

# Penrith – Wallerawang

## Network Control

Signallers at Blacktown, Penrith, Mount Victoria, Lithgow Coal Stage, Lithgow Yard and Network Controller UGLRL (Mayfield).

## Systems of Safeworking

The Main line between Penrith and Wallerawang is Rail Vehicle Detection (RVD) territory. It includes the sections:

<i>Section</i>	<i>System</i>	<i>Details</i>
Penrith–Springwood	RVD double-line	
Springwood–Lawson	RVD double-line	
Lawson–Katoomba	RVD double-line	
Katoomba–Mount Victoria	RVD double-line	
Mount Victoria–Newnes Junction	RVD double-line	
Newnes Junction–Edgecombe	RVD double-line	
Edgecombe–Zig Zag	RVD double-line bidirectional	Half-staffs and X, Y and Z keys available
Zig Zag–Lithgow	RVD double-line	
Lithgow–Wallerawang	RVD double-line	

# Penrith-Wallerawang



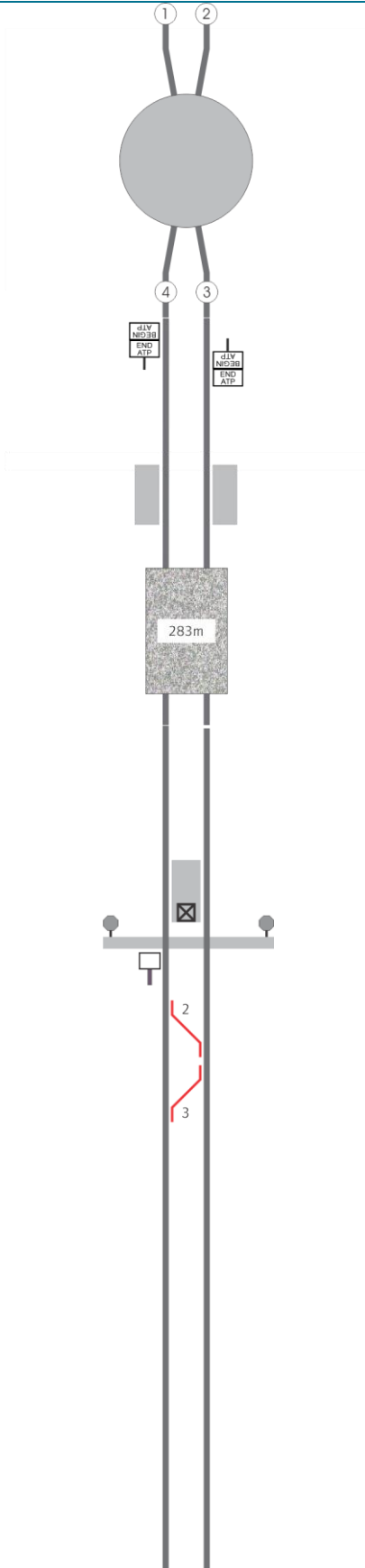

## Diagram











## Location details

### Penrith 54.986km (NLA 210)

- ① Up Main line (Lidcombe–Penrith)
- ② Down Main line (Lidcombe–Penrith)
- ③ Down Main line
- ④ Up Main line

-  59.201km Up Main line End ATP
-  59.258km Down Main line Begin ATP
-  63.515km Lapstone. Platforms 1, 2
-  65.248km Glenbrook

### Glenbrook 66.994km

-  Can be switched in
-  66.994km Glenbrook. Platform 1 and 2
-  67.182km Traffic hut: local control panel and frame A
-  67.226km Network access
-  67.239km Up BLOCK JOINT sign on Up Main line
-  If either release is taken, rail traffic in the approach track-circuit for signal 42.6 will not be shown in the track indicator diagram
-  Signals set at STOP by taking a release: Down signals 41.3 and 41.7; Up signals 42.6 and 42.0
-  67.253km Emergency crossover Down Main line to Up Main line: operated by frame A, released by Up or Down track-circuits
-  67.339km Emergency crossover Up Main line to Down Main line: operated by frame A, released by Up or Down track-circuits

# Penrith-Wallerawang

## Diagram

## Location details

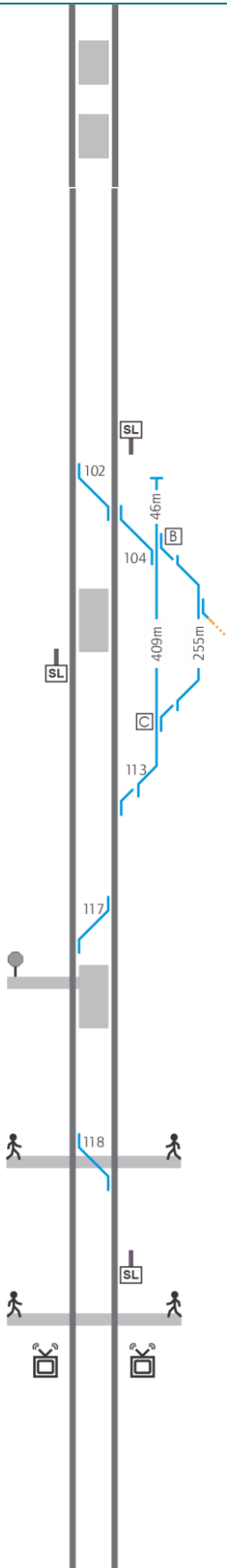

- 71.403km Blaxland. Platform 1 and 2
- 74.217km Warrimoo. Platform 1 and 2

### Springwood 79.604km



- ⚠ WARNING: This location has narrow track clearances
- ! Controlled from Blacktown (Katoomba panel)
- YL 75.843km Down signal SD1
- SL 76.309km Up SHUNT LIMIT sign on Down Main line
- EYL 76.542km Up signal 47.6
- 102 Down Main line to Up Main line
- 104 Down Main line to Down Refuge siding
- B 77.087km Down Refuge siding to Storage siding: key from releasing switch B, released from the signal box
- Storage siding to Coal Storage road NSW Rail Transport Museum private sidings
- ! The siding owners control rail traffic movements in the Coal Storage road and NSW Rail Transport Museum private sidings
- 77.323km Valley Heights. Platform 1 and 2
- SL 77.493km Down SHUNT LIMIT sign on Up Main line
- C 77.524km Down Refuge siding to Storage siding: key from releasing switch C, released from the signal box
- 113 Down Refuge siding to Down Main line
- 117 Down Main line to Up Main Line
- 79.604km Springwood. Platform 1 and 2
- 79.779km Network access
- ⤴ 80.205km Springwood: automatic. Keys at Springwood Station
- 118 Down Main line to Up Main Line
- SL 80.674km Down SHUNT LIMIT sign on Down Main line
- ⤴ 80.829km Faulconbridge: automatic. Keys at Springwood Station
- 80.968km Bearing and Brake Temperature System (BBT), Up and Down Main lines
- EYL 81.720km Down signal 50.9
- YL 82.093km Up signal SD46

# Penrith-Wallerawang

## Diagram

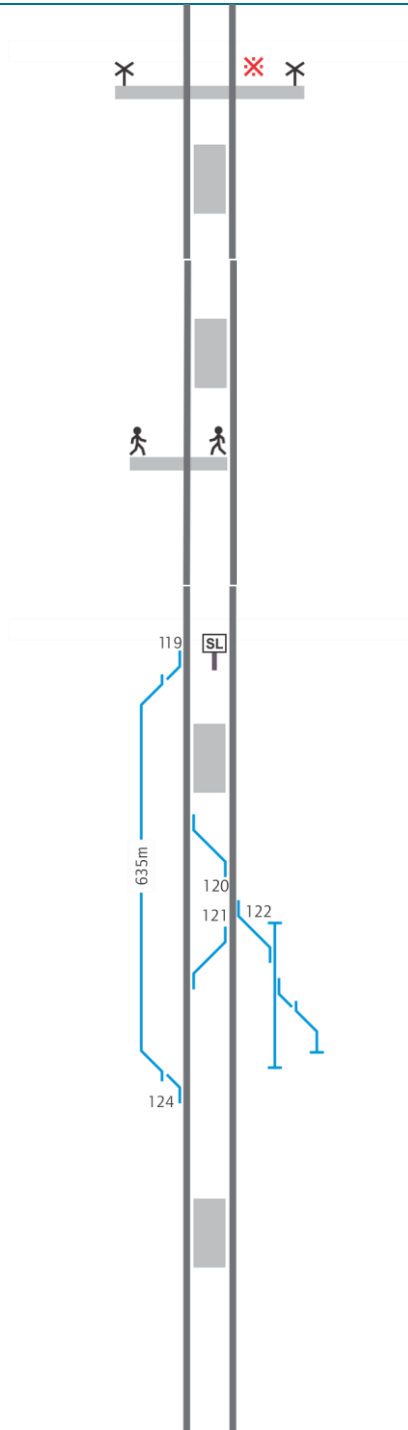

## Location details

- ⤴ 82.665km Honour Avenue: automatic, with Manual Operation and Master Emergency switch. Keys at Springwood Station. Linked
- ! See Special instructions
- ▬ 82.869km Faulconbridge. Platform 1 and 2
- ▬ 86.734km Linden. Platform 1 and 2
- ⤴ 86.876km Linden: automatic. Keys at Springwood SM
- ▬ 90.266km Woodford. Platform 1 and 2
- ⤴ 90.597km Network access
- ▬ 93.373km Hazelbrook. Platform 1 and 2
- ⤴ 93.616km Network access

## Lawson 95.936km



- ! Controlled from Blacktown (Katoomba panel)
- ⤴ 94.129km Up signal 58.6
- ⤴ 94.493km Down signal LN49
- ⤴ 95.923km Up SHUNT LIMIT sign on Down Main line
- 119 Up Refuge Loop line to Up Main line
- ▬ 95.936km Lawson. Platform 1 and 2
- 120 Down Main line to Up Main line
- 121 Up Main line to Down Main line (spiked, clipped and XL locked normal. Booked out of use)
- 122 Down Main line to Perway sidings. (Booked out of use)
- 124 Up Main line to Up Refuge Loop line
- ▬ 97.570km Bullaburra. Platform 1 and 2
- ⤴ 97.773km Up signal LN64
- ⤴ 98.065km Down signal 60.9

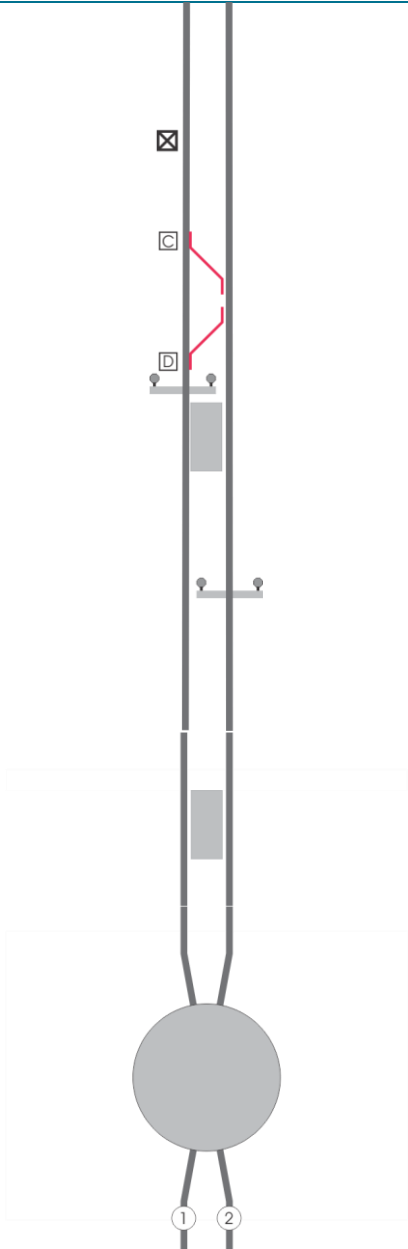

# Penrith-Wallerawang

## Diagram



## Location details

### Wentworth Falls 102.515km

- 102.104km Traffic hut: Annett lock
- 102.129km Emergency crossover Down Main line to Up Main line: key from Annett lock, released from special hasp with XL key
- ! Signals set at STOP by taking the release: Down signal 62.3; Up signal 63.8
- 102.264km Emergency crossover Down Main line to Up Main line: key from Annett lock, released from special hasp with XL key
- ! Signals set at STOP by taking the release: Down signal 62.3 and Up signal 63.8. If frame D lever 2 is reversed, also Down signal 63.7 and Up signal 63.4
-  102.448km Network access
-  102.515km Wentworth Falls. Platform 1 and 2
-  104.097km Network access

---

-  107.489km Leura. Platform 1 and 2

### Katoomba 109.835km (NLA 214)

- ! Controlled from Blacktown (Katoomba panel)
- ① Up Main line
- ② Down Main line

# Penrith-Wallerawang

**Diagram**

**Location details**

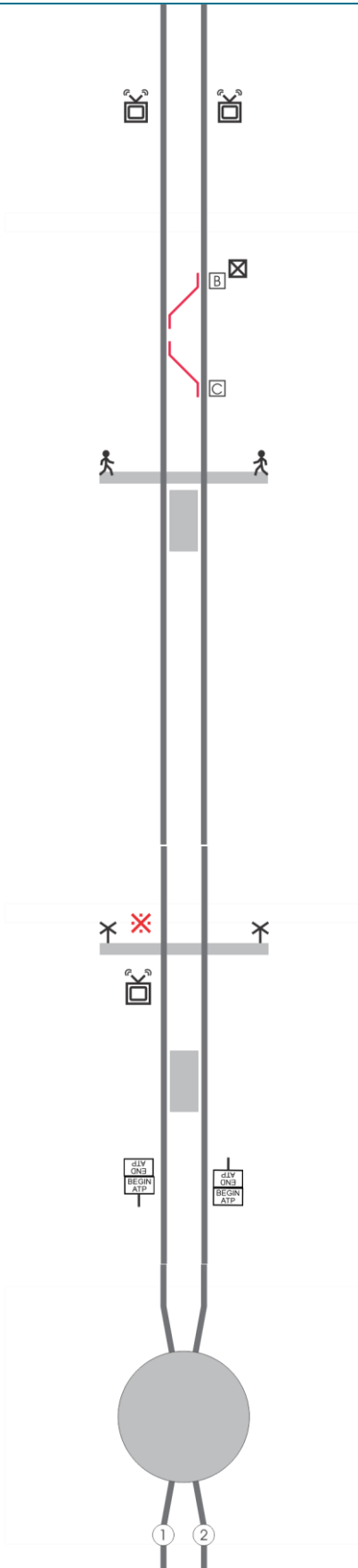

📡 114.548km Bearing and Brake Temperature System (BBT), Up and Down Main line

**Medlow Bath 115.713km**

- 📡 115.476km Traffic hut: Annett lock
- 📡 115.477km Emergency crossover Down Main line to Up Main line: key from Annett lock, released from special hasp with XL key
- ! Signals set at STOP by taking the release: Down signals 70.1 and 71.3; Up signals 72.8 and 71.8
- 📡 115.634km Emergency crossover Down Main line to Up Main line: key from Annett lock, released from special hasp with XL key
- ! Signals set at STOP by taking the release: Down signals 70.1 and 71.3; Up signals 72.8 and 71.8
- 🚶 115.705km Medlow Bath: automatic. Keys at Katoomba Station
- ▬ 115.713km Medlow Bath. Platform 1 and 2



- 🚶 120.419km Bundarra Street, Blackheath: automatic; with Manual Operation and Master Emergency switch. Keys at Blackheath Station and Mount Victoria Station
- ! See Special instructions
- 📡 120.470km Weighbridge (WB), Up Main line
- ▬ 120.622km Blackheath. Platform 1 and 2
- 📡 124.205km Down Main End ATP
- 📡 124.269km Up Main Begin ATP

**Mount Victoria 126.621km (NLA 216)**

- ! Controlled from Blacktown (Mount Victoria panel)
- ① Up Main line
- ② Down Main line





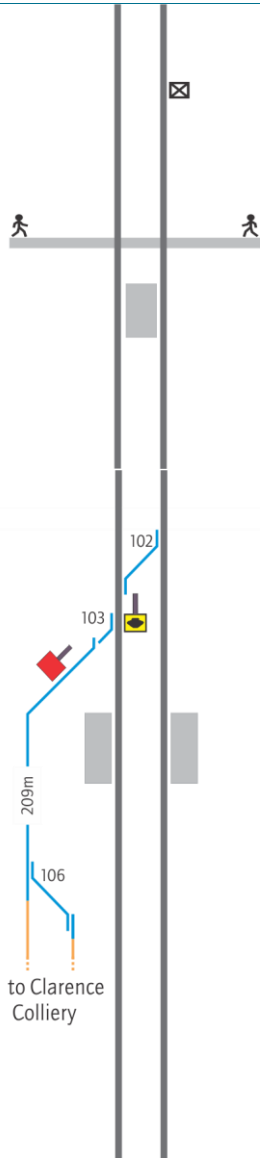

# Penrith-Wallerawang

## Diagram













## Location details

### Bell 137.082km

-  **WARNING:** This location has narrow track clearances
-  136.881km Traffic hut: Annett lock CD
-  137.076km Bell: automatic. Keys at Mount Victoria Station
-  Rail traffic on Up siding does not activate the warning equipment for the pedestrian level crossing
-  137.082km Bell. Platform 1 and 2

### Newnes Junction 141.718km

-  Controlled from Blacktown (Katoomba panel)
-  139.220km Up signal 86.4
-  139.578km Down signal NJ1
-  102 Down Main line to Up Main line
-  103 Coal siding to Up Main line
-  141.656km Down electric train STOP sign on Coal siding
-  The siding owners control rail traffic movements in the Coal siding Balloon Loop line
-  141.718km Newnes Junction. Platforms 1, 2
-  106 Clarence Colliery Departure road to Coal siding
-  141.865km Down signal 88.1
-  142.308km Up signal NJ30

# Penrith-Wallerawang

## Diagram



## Location details

### Edgecombe 145.305km

! Controlled from Lithgow Coal Stage

! See Special Instructions

 144.077km Down signal 89.5

 144.280km Up signal 89.6

 The half pilot staffs for the Edgecombe–Zig Zag section are inscribed “EDGECOMBE 90.3 DOWN MAIN” and “EDGECOMBE 90.3 UP MAIN”

 Down Main line to Up Main line

 Down Main line to Up Main line

 145.817km No 1 Zig Zag

 146.523km YL/EYL: Up signal U91.0

 146.548km EYL/YL: Up signal D91.0



# Penrith-Wallerawang

**Diagram**

**Location details**

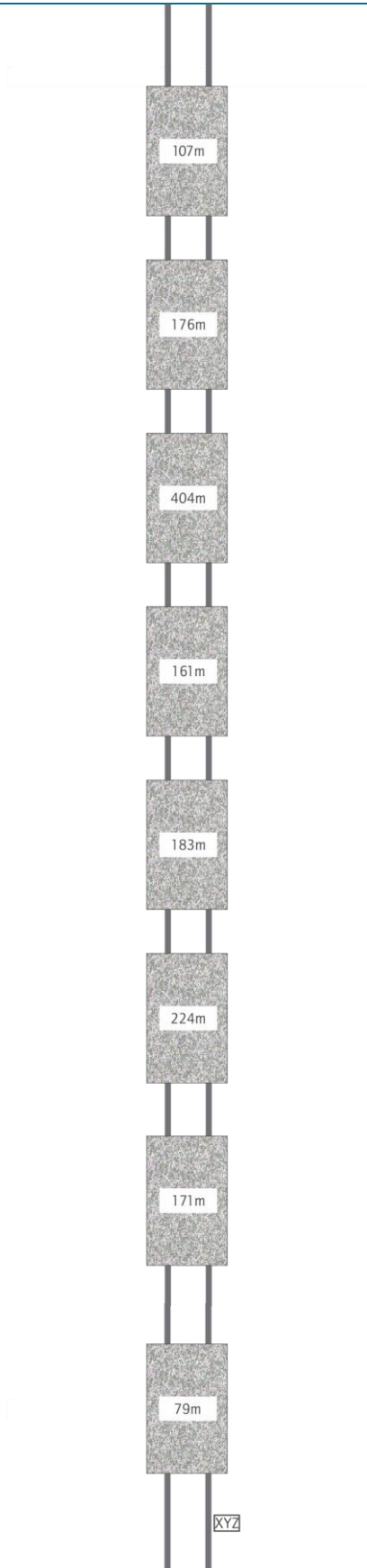

- ▮ 146.835km No 2 Zig Zag
- ▮ 147.224km No 3 Zig Zag
- ▮ 147.519km No 4 Zig Zag
- ▮ 147.987km No 5 Zig Zag
- ▮ 148.227km No 6 Zig Zag
- ▮ 148.471km No 7 Zig Zag
- ▮ 148.868km No 8 Zig Zag
- ▮ 149.168km No 9 Zig Zag
- ▮ XYZ 149.333km X, Y and Z keys for the Edgecombe–Zig Zag section

# Penrith-Wallerawang

## Diagram

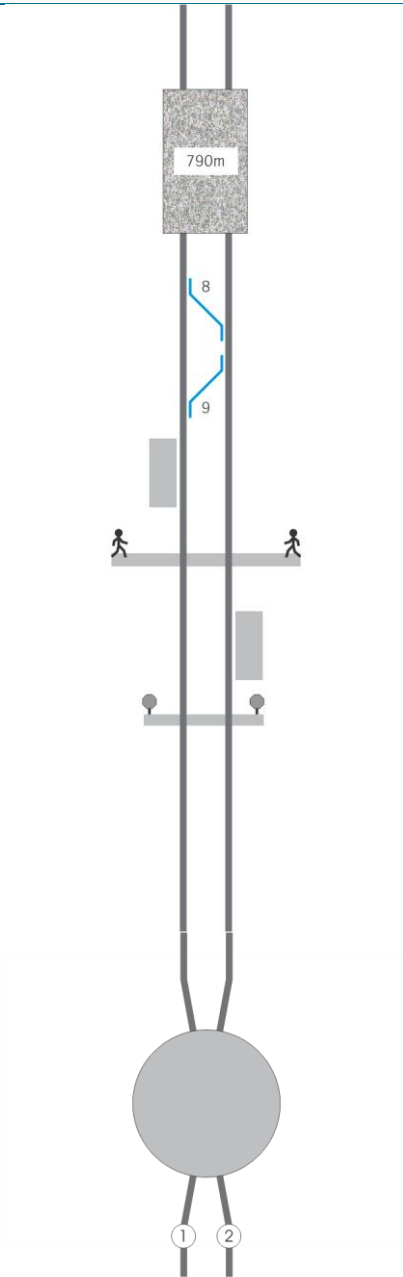

## Location details

### Zig Zag 150.946km



- ! See Special Instructions
- YL 149.347km YL/EYL: Down signal 92.7D
- EYL 149.347km EYL/YL: Down signal 92.7U
- ||||| 149.493km No 10 Zig Zag
- <sup>8</sup> Down Main line to Up Main line
- <sup>9</sup> Down Main line to Up Main line
- ! The half pilot staffs for the Edgecombe–Zig Zag section are inscribed "ZIG ZAG 93.6 DOWN MAIN" and "ZIG ZAG 93.6 UP MAIN"
- EYL 150.701km EYL: Down signal 93.7
- 150.946km Zig Zag. Platforms 1, 2
- ⤴ 150.966km Zig Zag: automatic. Keys at Lithgow
- ⦿ 150.997km Network Access crossing
- YL 150.988km YL: Up signal 93.8
- ! Zig Zag and Lithgow abut on the Up Main line

### Lithgow 155.687km (NLA 218)



- ① Up Main line
- ② Down Main line

# Penrith-Wallerawang

## Diagram

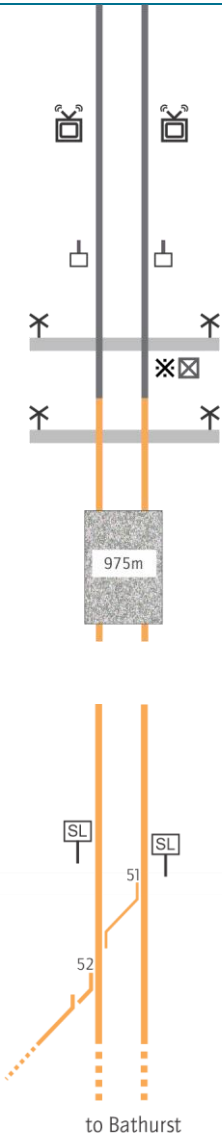

## Location details

- 156.538km Bearing and brake temperature system: broadcasts WB radio message and reports to Lithgow Coal Stage. Signaller tells Network Controller and warns Train Crew
- 156.550km 2 x Down electric train STOP signs on Down and Up Main lines
- 158.098km Geordie Street, Bowenfels: automatic, with Manual Operation switch. Keys at Lithgow Yard signal box
- 158.120km Traffic hut
- 161.840km Oakey Forest Road, Marrangaroo: automatic. Keys at CRN depot Bathurst
- WARNING:** This location has narrow track clearances
- 164.822km Marrangaroo

## Wallerawang 171.175km



- Controlled from UGLRL (Mayfield)
- 166.865km EYL: Up signal 166.8
- 167.240km YL: Down signal WG1
- 167.770km Up SHUNT LIMIT sign on Up Main line
- 168.747km Up SHUNT LIMIT sign on Down Main line
- 51 Down Main line to Up Main line
- 52 Lidsdale Branch line to Up Main line

## Penrith-Wallerawang

### Special instructions

#### Signal Key Switches (Emu Plains – Valley Heights)

Signal Key Switches are fitted to the automatic signals listed in the table below.

Signal Key Switch may be used for worksite protection in accordance with the following Network Rule & Procedures:

- NWT 306 Track Work Authority
- NWT 320 Signal Key Switch Blocking
- NPR 702 Using a Track Work Authority
- NPR 753 Using Signal Key Switch Blocking
- NPR 754 Using a Signal Key Switch

<i>Line</i>	<i>Worksite limits</i>	<i>First affected signal/s</i>	<i>Protecting signal fitted with a Key Switch</i>
Down Main	Signal 38.9 to Signal 41.7	38.3 on the Down Main	38.9 (Lapstone)
	Signal 41.7 to Signal SD1 (follow additional requirements)		
Up Main	Signal 42.6 to Signal 42.0	43.6 on the Up Main	42.6 (Glenbrook)
	Signal 42.0 to 36.6 (follow additional requirements)		

#### Additional requirements when establishing Signal Key Switch Blocking

When establishing a worksite using Signal Key Switch Blocking on the:

- Down Main line between Signal 41.7 and Signal SD1
- Up Main line between Signal 42.0 and Signal 36.6

The Protection Officer must:

- make sure that 2 points and 3 points remain clipped and locked unless protection is provided on both the Up and Down Main lines, and
- place a Danger Tag with their name and contact details and a dedicated padlock on Glenbrook control panel door lock.

## Penrith-Wallerawang

### Operation of Signal 52.0 to prevent long trains standing across Faulconbridge Level Crossing

The operation of the control of 52.0 Signal to prevent long trains standing across Faulconbridge Road Level Crossing when held at Springwood signal SD46 is as follows:

1. When SD46 is at stop, 52.0 signal will also be at stop.
2. When a train approaches 52.0 signal, and the track between 52.0 and SD46 is clear, the signal will clear to caution providing that train has been measured as being approximately 560 m or less in length. This measurement is taken approximately 1100 m before 52.0 signal.
3. If the train is longer than approximately 560 m, 52.0 signal will remain at stop.
4. When SD46 is then cleared, 52.0 will also clear.

A notice board inscribed 'This Signal must not be passed at stop without authority of the Signaller' is provided on 52.0 Signal.

### Emergency Operation of Points at Lawson

All points will be fitted with ESML equipment for emergency hand operation.

### Operation 121 Points

121 points are power operated and controlled from Blacktown Signal Box. There are no signal routes leading over the points when reverse. 121 points are Spiked, Clipped and XL Locked Normal and booked out of use, and are provided for planned work or emergency situations where they can be booked into service and called reverse.

### Operation 122 Points

122 Points are set by the Signaller but operated locally by a Qualified Worker using 122 points pushbutton unit. The pushbutton unit consists of an SL locked box that contains an 'Operate Points' pushbutton and a 'Points Free' indicator (flashing green). Instructions for working trains into or out of the Perway Sidings are inscribed inside the pushbutton unit locked box. A telephone is also provided.

### Operation of 122 points by setting signal routes

The Qualified Worker will contact the Signaller to discuss the train movement.

The Signaller will set 57(S)A or 59(S)A or 58(S) route's as required.

The signal route on the ATRICS control panel will set but the signal will remain at stop (i.e. 122 points have not operated) and the 'Points Free' indication on 122 points pushbutton unit will flash green.

When advised by the Signaller, the Qualified Worker will visually ensure the track over the points is clear and any approaching track vehicles are stationary. Observe the 'Points Free' indicator is flashing green.

Depress and hold the pushbutton for 2 seconds to operate the points.

## Penrith-Wallerawang

The signal will clear for the selected route once the points are in the correct position.

### Operation of 122 points by calling the points

The Qualified Worker will contact the Signaller to discuss the train movement.

The Signaller will call 122 points either 'normal' or 'reverse' as required.

The points indications on the ATRICS panel will be unchanged (i.e. 122 points have not operated) and the 'Points Free' indication on 122 points pushbutton unit will flash green.

When advised by the Signaller, the Qualified Worker will visually ensure the track over the points is clear and any approaching track vehicles are stationary. Observe the 'Points Free' indicator is flashing green.

Depress and hold the pushbutton for 2 seconds to operate the points.

On the ATRICS control panel 122 points will indicate either 'normal' or 'reverse', once the points are in the new position.



#### Note

122 points must be restored to the normal position on completion of the train movements

### Operation 123 Release (Lever 1D and 2D)

123 Release is operated by the Signaller with a Qualified Worker operating levers 1D and 2D.

Levers 1D and 2D are secured with an SL Lock.

There is a 'Point Lock Release' unit for each lever. The Point Lock Release units consist of an SL locked box that contains a 'Pushbutton' to release the Point lock and a 'Release Available' indicator. Instructions for working trains into and out of the Perway Siding are inscribed inside the Point Lock Release unit locked box.

### Operation of 123 Release

The Qualified Worker will contact the Signaller to discuss the train movement.

The Signaller will provide 123 Release.

The 'Release Available' indication in both 1D and 2D 'Point Lock Release' units will flash green.

The Qualified Worker will now depress and hold the pushbutton for 1 second.

The 'Release Available' indication will now display a steady green for 10 seconds during which time the lever to which the 'Point Lock release' unit applies will be free to operate.

If the points are not operated within 10 seconds, the pushbutton will need to be pressed again.

## Penrith-Wallerawang



### Warning

Both points and catchpoints (1D and 2D) must be operated to the correction position for the required train movement.

Once the train movements are complete restore both levers 1D and 2D to the normal position. This action does not require the pushbutton to be pressed.

Advise the Signaller on completion of the shunting.

The Signaller will now restore 123 Release to the normal position.

Standard release indications are displayed on the ATRICS control panel for 123 Release.



### Note

If after depressing the Point Lock Release pushbutton the points do not release, the signal electrician will need to be called to release the point lock. The hand operated release lever shall be secured by a Falcon 4 lock.

## Honour Avenue and Bundarra Street level crossing equipment

The level crossing warning equipment for Honour Avenue level crossing, Faulconbridge and Bundarra Street level crossing, Blackheath are linked with the road traffic control equipment.

When the warning equipment has been isolated during work on track, the Signals Maintenance Representative must be informed before a rail vehicle is to occupy the track-circuiting for an extended period.

## Honour Avenue level crossing

Honour Avenue level crossing is fitted with a single Master Emergency switch. Operation of the Master Emergency switch will place Down signal 50.9 and Up signal 52.0 to STOP. They will remain at STOP until the Manual Operation switch is operated and the level crossing equipment has operated and the booms are lowered or the Master Emergency switch is restored.

## Bundarra Street level crossing

Bundarra Street level crossing is fitted with a single Emergency Control switch.

Operation of the Emergency Control switch will place Down signal 74.3 and Up signal 75.2 to STOP. They will remain at STOP until the Manual Operation switch is operated and the level crossing equipment has operated and the booms are lowered or the Master Emergency switch is restored.

## Penrith-Wallerawang

### Edgecombe–Zig Zag



#### **Warning**

Out-of-gauge rail traffic between Edgecombe and Zig Zag must travel on the Up Main line only to avoid being fouled by Down-side signal troughs in the Zig Zag tunnels

### Zig Zag–Lithgow

Bank locomotive working is authorised between Lithgow and Zig Zag.

A coupled bank locomotive may release only at an attended yard.

A non-coupled bank locomotive must release from the assisted train before the Zig Zag Up accept signal 93.8.

If the assisting non-coupled bank locomotive cannot release from an assisted train, it must be detached at an attended location.

If pilot staff working is in operation, the Driver of an assisting non-coupled bank locomotive must hold the pilot staff during the assist and the return to Lithgow.

If an assisted train fails, the bank locomotive must be coupled to the failed train.

The speed of a propelled train must not exceed 15km/h.

If the failed train returns to Lithgow, the Driver of the bank locomotive must hold the documentation for special working.



## Penrith-Wallerawang

### Sydney Trains – CRN Interface Boundaries

The Network Control boundaries between the CRN and Sydney Trains territories define the location for Network Controller responsibilities.

<i>Line</i>	<i>Limits</i>	<i>Sydney Side</i>	<i>Country Side</i>
Down Main	Signal WG1	Signaller Lithgow Yard Box	CRN Network Control Officer
Up Main	Signal 166.8	Signaller Lithgow Yard Box	CRN Network Control Officer

### Application of Network Rules

<i>Line</i>	<i>Limits</i>	<i>Network Rules</i>
Down Main	Country Side of WG1 Signal	CRN
	Sydney Side of WG1 Signal	Sydney Trains
Up Main	Country Side of 166.8 Signal	CRN
	Sydney Side of 166.8 Signal	Sydney Trains

On the Sydney side of Signal WG1 on the Down Main line and on the Up Main line up to and Including Signal 166.8, all work on track authorities, proceed authorities and special working must be authorised by the responsible Sydney Trains Signaller or Network Controller.

### Advice of train departure

In the Up direction, the CRN Network Control Officer will advise the Sydney Trains Network Controller prior to a departure of rail traffic from Rydal and Baal Bone.

In the Down direction, the Sydney Trains Network Controller will advise the CRN Network Control Officer prior to a departure of rail traffic from Lithgow Coal Stage.

### Work on Track

All work on track authorities on the Down Main line on the Sydney side of Signal WG1 and on the Up Main line on the Sydney side of Signal 166.8 must be authorised by the Sydney Trains Network Controller.

## Penrith-Wallerawang

### Local Possession Authority (LPA)

#### CRN only LPA

<i>Line</i>	<i>Limits</i>
Down Main	Country side of 97.1 signal
Up Main	Sydney side of 166.8

#### Down Main line

CRN must advise Sydney Trains in advance of the request to implement an LPA on the country side of Signal 97.1 and be implemented in accordance with the Sydney Trains Network Rules and Procedures.

CRN and Sydney Trains will advertise possessions on a STN and CTN respectively.

CRN must request Sydney Trains Engineering and Maintenance to make arrangements for 97.1 signal to be maintained at STOP and booked out of use for the duration of the LPA.

#### Up Main line

CRN must advise Sydney Trains in advance of the request to implement an LPA on the Sydney side of Signal 166.8 and be implemented in accordance with the Sydney Trains Network Rules and Procedures.

CRN and Sydney Trains will advertise possessions on a STN and CTN respectively.

Sydney Trains will request that Signal 166.8 is maintained at STOP and booked out of use for the duration of the LPA.

#### Sydney Trains only LPA

<i>Line</i>	<i>Limits</i>
Down Main	Sydney side of WG1 signal
Up Main	Sydney side of 166.8 signal

Sydney Trains will advertise the possession on a Special Train Notice (STN).

Where the limits of an LPA extend to Signal 166.8 on the Up Main line, Sydney Trains will request that Signal 166.8 is maintained at STOP and booked out of use for the duration of the LPA.

#### Sydney Trains – CRN back to back LPA

<i>Line</i>	<i>Limits</i>
Down Main	WG1 signal
Up Main	166.8 signal

## Penrith-Wallerawang

CRN and Sydney Trains will advertise possessions on STN and CTN respectively.

Where a back to back possession is implemented, the following instructions will apply:

- Worksites and rail vehicles that need to move from Sydney Trains territory to CRN territory are authorised and supervised by the CRN Possession Protection Officer.
- Worksites and rail vehicles that need to move from CRN territory to Sydney Trains territory are authorised and supervised by the Sydney Trains Possession Protection Officer.

### Track Occupancy Authority (TOA)

#### Down Main line

The Sydney Trains Network Controller is responsible for authorising a Track Occupancy Authority on the Down Main line on the Sydney side of Signal WG1.

The Signaller at Lithgow Yard Box is responsible for issuing and protecting a TOA on the Down Main line on the Sydney side of Signal WG1.

If a worksite needs to be established within 500 metres on the Sydney side of WG 1 signal, an abutting TOA for the country side of WG 1 signal must be in place prior to the establishment of the worksite.

Before work commences the worksite must be protected in accordance with the Network Rules relevant for the location of the work.

#### Up Main line

The Sydney Trains Network Controller is responsible for authorising a Track Occupancy Authority on the Up Main line on the Sydney side of Signal 166.8.

The Signaller Lithgow Yard Box is responsible for issuing a TOA on the Up Main line on the Sydney side of Signal 166.8.

The Signaller Lithgow Yard Box must confer with the CRN Network Control Officer and the Protection Officer. The Signaller Lithgow Yard Box must obtain an assurance from the CRN Network Control Officer that protecting signals are at STOP with blocking facilities applied prior to issuing the TOA. The Signaller Lithgow Yard Box must make sure that the CRN Network Control Officer has a copy of the TOA form.

If a worksite needs to be established within 500 metres on the Sydney side of 166.8 signal, an abutting TOA for the country side of 166.8 signal must be in place prior to the establishment of the worksite.

Before work commences the worksite must be protected in accordance with the Network Rules relevant for the location of the work.

## Penrith-Wallerawang

### Track Work Authority (TWA)

#### Down Main line

The Sydney Trains Network Controller is responsible for authorising a Track Work Authority on the Sydney side of Signal WG1.

The Signaller at Lithgow Yard Box is responsible for issuing a TWA on the Down Main line on the Sydney side of Signal WG1.

The Signaller Lithgow Yard Box is responsible for protecting the TWA on the Down Main line where the TWA is to be protected using Controlled Absolute Signals.

#### Up Main line

The Sydney Trains Network Controller is responsible for authorising a Track Work Authority on the Sydney side of Signal 166.8.

The Signaller Lithgow Yard Box is responsible for issuing a TWA on the Up Main line Sydney side of Signal 166.8.

A TWA on the Up Main line on the Sydney side of Signal 166.8 must only be protected in accordance with the Sydney Trains Network Rules and Procedures using Handsignalers only.

The Signaller Lithgow Yard Box must advise the CRN Network Control Officer details of the TWA.

### Absolute Signal Blocking (ASB) and Route Control Blocking (RCB)

The Absolute Signal Blocking (ASB) and the Route Control Blocking (RCB) method of protection must not be used on the Up and Down Main lines Sydney side of Signal WG1 and Signal 166.8.

### Lookout Working

Lookout Working on the Up and Down Main lines on the Sydney side of Signal WG1 and Signal 166.8 must be conducted in accordance with the Sydney Trains Network Rule and Procedure *NWT 310 Lookout Working* and *NPR 711 Using Lookouts*.

### Activities associated with in service rail traffic

Activities associated with service rail traffic on the Up and Down Main lines the Sydney side of Signal WG1 and Signal 166.8 must be conducted in accordance with Sydney *Trains Network Rule NTR 432* and *Network Procedure NPR 750*.

If adjacent line protection for an activity associated with in-service rail traffic is required on the Up Main line on the Sydney side of Signal 166.8 the Signaller Lithgow Yard Box must request the CRN Network Control Officer to place Signal WG 6 and Signal WG 10 at STOP with blocking facilities applied.

## Penrith-Wallerawang

### Applying Blocking facilities

If it is necessary to place signals at STOP and apply blocking facilities to Signal WG 6 and Signal WG 10, the CRN Network Control Officer will provide the Signaller Lithgow Yard Box with a security code/s.

The Signaller Lithgow Yard Box must make a permanent record of the security code/s.

The Signaller Lithgow Yard Box must provide the security code/s to the CRN Network Control Officer when blocking facilities are no longer required.

### Special Working

#### Special Proceed Authority (SPA)

Special Proceed Authorities (SPA) on the Down Main line on the Sydney side of Signal WG1 and on the Up Main line on the Sydney side of Signal 166.8 must be authorised and issued in accordance with *NSY 514 Special Proceed Authority*.

#### Down Main line

The Sydney Trains Network Controller will be responsible for authorising and issuing Special Proceed Authorities (SPA) on the Down Main line on the Sydney side of Signal WG1.

The Sydney Trains Network Controller must confer with the CRN Network Control Officer prior to issuing the authority and must make sure that the CRN Network Controller has a copy of the SPA form (NRF 005).

#### Up Main line

The Sydney Trains Network Controller will be responsible for authorising and issuing Special Proceed Authorities (SPA) on the Up Main line on the Sydney side of Signal 166.8.

The Sydney Trains Network Controller must confer with the CRN Network Control Officer prior to issuing the authority and must make sure that protecting signals have been placed at STOP with blocking facilities applied or conflicting rail traffic movements have been restrained. The Sydney Trains Network Controller must make sure that the CRN Network Control Officer has a copy of the SPA form (NRF 005).

#### Pilot Staff Working (PSW)

Pilot Staff Working (PSW) must not be implemented on the Up and Down Main lines on the Sydney side of Signal WG1 and Signal 166.8.

#### Manual Block Working

The Signaller Lithgow Yard Box and the CRN Network Control Officer must confer prior to dispatching rail traffic that may not effectively operate track circuits (must be block worked).

## Penrith-Wallerawang

Manual Block Working on the Up and Down Main lines Sydney side of Signal WG1 and Signal 166.8 must be implemented in accordance with NSY 512 Manual Block Working.

### Up Main line

If Manual Block Working is implemented on the Up Main line on the Sydney side of Signal 166.8, the Signaller Lithgow Yard Box must obtain an assurance from the CRN Network Control Officer that blocking facilities have been applied.

The Signaller Lithgow Yard Box must tell the CRN Network Control Officer when the rail traffic has arrived complete beyond Signal 97.0.

### Down Main line

If Manual Block Working is implemented on the Down Main line on the Sydney side of Signal WG1, the CRN Network Control Officer must obtain an assurance from the Signaller Lithgow Yard Box that blocking facilities have been applied. The CRN Network Control Officer must tell the Signaller Lithgow Yard Box when the rail traffic has arrived complete beyond Signal WG1.

### CAN Block Working

CAN Block Working must not be implemented on the Up and Down Main lines Sydney side of Signal WG1 and Signal 166.8.

### Conditions affecting the Network (CAN)

If a Condition affecting the Network (CAN) is reported between Lithgow Yard Limits and Wallerawang Yard Limits, the CRN Network Control Officer and Signaller Lithgow Yard Box must notify each other.

The Signaller Lithgow Yard Box is responsible for issuing CAN warning on the Down Main line. Written CAN warnings must be issued on NRF 004 form.

The CRN Network Control Officer is responsible for issuing CAN warning on the UP Main line. Written CAN warnings must be issued on CNRF 004 form.

### Removal and restoration of the 1500v supply

The removal and restoration of the 1500v supply on the Sydney side of Signal WG1 and Signal 166.8 must be conducted in accordance with the Sydney Trains Network Rules and Procedures.

The Sydney Trains Network Controller must coordinate the removal and restoration of supply. Prior to giving clearance for the removal of supply, the Sydney Trains Network Controller must confer with the CRN Network Control Officer and obtain the necessary assurances.

### Passing Signals at STOP

All signals on the Sydney side of Signal WG1 on the Down Main line and all signals on up to and Including Signal 166.8 on the Up Main line must be passed at STOP in accordance with Sydney Trains Network Rules and Procedures.

## Penrith-Wallerawang

### Placing Temporary Speed Signs

Temporary Speed restrictions on the Up and Down Main lines Sydney side of the property boundary 158.800km must be managed using Sydney Trains Temporary Speed signs and standards.

Temporary Speed restrictions on the Up and Down Main lines country side of the property boundary 158.800km must be managed using CRN Temporary Speed signs and standards.

The Warning signs of the respective networks may be used where there is insufficient distance between the property boundary and the speed restriction.

### Recognition of Safeworking Competencies/Certification

Recognition of RISI and Railway Safety Worker Competencies. Where work or activities occur between Lithgow and Wallerawang require RISI or a RSW competency, mutual recognition of RISI and RSW or RIW cards will apply.

Recognition of RISI and RSW competencies are detailed in the table below.

<i>Workers</i>	<i>RISI</i>	<i>RSW competency</i>
CRN Employees	RIW Card	RIW Card
Contractors engaged by CRN	RIW Card	RIW Card
Sydney Trains employees	RIW card or RSW issued by TfNSW	RSW issued by TfNSW
Contractors engaged by Sydney trains	RIW Card	RIW Card

### Related documents

- NLA 200 Lidcombe–Penrith*
- NLA 210 Penrith*
- NLA 214 Katoomba*
- NLA 216 Mount Victoria*
- NLA 218 Lithgow*

### Effective date

15 April 2024