

# 21

## **weekly notice**

Monday, 16 May 2022  
Sunday, 22 May 2022



## See online for all Safeworking Information

[www.railsafe.org.au](http://www.railsafe.org.au)

Safeworking information, including Weekly Notices and SAFE Notices, is available on the RailSafe website.

By accessing Weekly Notices and SAFE Notices online, you will receive safety information more quickly. Weekly Notices remain on the RailSafe website for two years; Permanent and Temporary SAFE Notices remain online as long as they are current.

Anyone needing back issues of Weekly Notices and SAFE Notices should contact the Network Rules unit.

If you are outside Sydney Trains, you can reach the RailSafe website via the following address:

[www.railsafe.org.au](http://www.railsafe.org.au)

Other Safeworking documents, such as Network Rules, Network Procedures, Network Local Appendices, Safeworking Policies, SafeTracks flyers, and contractor information are also available online.

**Director Safety and Standards  
Sydney Trains**

*Continued on next page*

## CONTENTS

PUBLICATION DEADLINES AND SUBMISSION OF ARTICLES	5
WATERFALL (ILLAWARRA) – MTMS2 WATERFALL STABLING FACILITY PROJECT SIGNALLING STAGE 8/9/10 – INSTALLATION OF NEW 302B, 311B AND 60A CATCH POINTS, 305B AND 307 POINTS, INSTALLATION OF AN ADDITIONAL PLATFORM 2 GUARDS INDICATOR AND UPGRADE TO W34 SIGNAL <b>(DIAGRAM)</b>	6
BLACKHEATH (WEST) – BLACKHEATH STATION UPGRADE PLATFORM PEDESTRIAN CROSSING REMOVAL <b>(DIAGRAM)</b>	8
SUTHERLAND – CRONULLA – DIGITAL SYSTEMS PROJECT – ETCS LEVEL 2 BALISES AND SIGNAGE INSTALLATION WORKS	9
RHODES TO STANMORE - COMMISSIONING OF AUTOMATIC TRAIN PROTECTION (ATP) ETCS LEVEL 1 LIMITED SUPERVISION <b>(DIAGRAM)</b>	10
REGENTS PARK, AUBURN TO STANMORE - COMMISSIONING OF AUTOMATIC TRAIN PROTECTION (ATP) ETCS LEVEL 1 LIMITED SUPERVISION <b>(DIAGRAM)</b>	12
MOUNT VICTORIA (WEST) – MOUNT VICTORIA AREA REMODELLING (MVAR) – UP SIDING MODIFCATION & REMOVALS	15
FAULCONBRIDGE (WESTERN) – REMOVAL OF BELL TIMER AT SIR HENRYS PARADE LEVEL CROSSING	16
WOLLI CREEK (UP NEW SOUTHERN RAILWAY) – MTMS2 STAGE 2- INSTALLATION OF NEW UNCOMISSIONED SR9.6 AND SR9.8 SIGNALS <b>(DIAGRAM)</b>	17

---

METROPOLITAN FREIGHT LINES – TOC UPDATE & REMOVAL OF SPEED SIGN	18
WOLLONGONG (ILLAWARRA) – MTMS2 WOLLONGONG LNIF ENABLING – STAGE 4 FINAL CONFIGURATION OF UP AND DOWN YARDS.	21
STATUS OF TOM NOTICES	22
STATUS OF PERMANENT SAFE NOTICES	24
STATUS OF NETWORK MANUALS AND FORMS	25
DISTRIBUTION OFFICERS	27

**PUBLICATION DEADLINES AND SUBMISSION OF ARTICLES**

Dates of the next three Weekly Notices and deadlines for articles are:

<i>Weekly Notice</i>	<i>For Week</i>	<i>Deadline</i>
22	23/05/2022 – 29/05/2022	26/04/2022
23	30/05/2022 – 05/06/2022	03/05/2022
24	06/06/2022 – 13/06/2022	10/05/2022

To meet printing and distributing schedules, articles for a Weekly Notice must be received by its deadline.

Articles submitted after a deadline will be published in the next issue of the Weekly Notice. This may result in information not being distributed in time for it to be acted upon.

When submitting articles, please include your name, position title, telephone numbers and email address at the end of the articles as shown below:

**Steve Swanson**

Network Rules Specialist

Tel: 02 8922 4183 (external) 2 4183 (internal)

Email: [stephen.swanson@transport.nsw.gov.au](mailto:stephen.swanson@transport.nsw.gov.au)

## **WATERFALL (ILLAWARRA) – MTMS2 WATERFALL STABLING FACILITY PROJECT SIGNALLING STAGE 8/9/10 – INSTALLATION OF NEW 302B, 311B AND 60A CATCH POINTS, 305B AND 307 POINTS, INSTALLATION OF AN ADDITIONAL PLATFORM 2 GUARDS INDICATOR AND UPGRADE TO W34 SIGNAL**

Commencing at 0200 hours on Saturday, **21 May 2022**, and continuing until 0200 hours on Monday, 23 May 2022, the following works will be carried out:

- New 302B catch points will be installed on the Up Goods Loop (Future) at 36.906km. The new catch points will be spiked, clipped, XL locked and detected normal.
- 302B catch points will be fitted with a Siemens D84M MKIII point machine with an in-bearer spherolock arrangement.
- 302 points Emergency Operation Lock (EOL) keys will be installed in 302 EOL box located near W1 location.
- Temporary buffer stop will be installed countryside of 302B points at 36.937km.
- New 305B points will be installed on the No.1 Up Siding (Future) at 37.505km. The new turnout will be spiked, clipped, XL locked and detected normal.
- 305B points will be fitted with a Siemens D84M MKIII point machine with an in-bearer spherolock arrangement.
- 305 points Emergency Operation Lock (EOL) keys will be installed in 305 EOL box located near W3 location.
- New 307 turnout will be installed on the No.1 Up Siding (Future) at 37.519km.
- 307 points will be fitted with a Siemens D84M MKIII point machine with an in-bearer spherolock arrangement.

- New 311B catch points will be installed on the Up Refuge Loop (Future) at 38.521km. The new catch points will be spiked, clipped, XL locked and detected normal.
- 311B catch points will be fitted with a Siemens D84M MKIII point machine with an in-bearer spherolock arrangement.
- 311B Emergency Operation Lock (EOL) key will be installed with existing 311A key located in 311 EOL box.
- New 60A catch points will be installed on Up Goods Loop (Future) at 38.678km. The new catch points will be spiked, clipped, XL locked and detected normal.
- 60A catch points will be fitted with a Siemens D84M MKIII point machine with an in-bearer spherolock arrangement.
- 60A Emergency Operation Lock (EOL) key will be installed with existing 60B key located in 60 EOL box.
- An additional up direction Guards Indicator will be installed on platform 2 and will operate in conjunction with 12 Signal.
- 34 Signal profile will change. The green aspect will be disconnected and booked out of use.
- A Drivers Diagram showing the new arrangement appears in this Weekly Notice.

**VER 09022022**  
**DIAGRAM VER 09022022**

**Adam Toffolo**

Signalling Commissioning Engineer, JMDR

Mob: 0416 942 861

Email: adam.toffolo@jmdr.com

**Joe Trinh**

Design Delivery Manager, JMDR

Mob: 0411566162

Email: joe.trinh@jmdr.com

SIGNAL	ROUTE	DESTINATION	INDICATION
<b>5</b>	5(M)A	DOWN REFUGE	-
	5(M)B	DOWN MAIN	D
	5(M)C	UP MAIN	U
	5(M)D	UP REFUGE	R
	5(M)E	UP GOODS	G #
	5(S)A	DOWN REFUGE	DR
5(S)B	DOWN MAIN	DM	

# OUT OF USE

SIGNAL	ROUTE	DESTINATION	INDICATION
<b>1</b>	1(M)A	DOWN REFUGE	-
	1(M)B	DOWN MAIN	-
	1(S)A	DOWN REFUGE	DR
	1(S)B	DOWN MAIN	DM

SIGNAL	ROUTE	DESTINATION	INDICATION
<b>3</b>	3(M)A	DOWN MAIN	-
	3(M)B	UP MAIN	U
	3(M)C	UP REFUGE	R
	3(M)D	UP GOODS	G #
	3(S)	DOWN MAIN	-

# OUT OF USE

SIGNAL	ROUTE	DESTINATION	INDICATION
<b>11</b>	11A	DOWN MAIN	D
	11B	UP MAIN	U
	11C	UP REFUGE	R
	11D	UP GOODS	G #
		GREEN LIGHT	•

# OUT OF USE

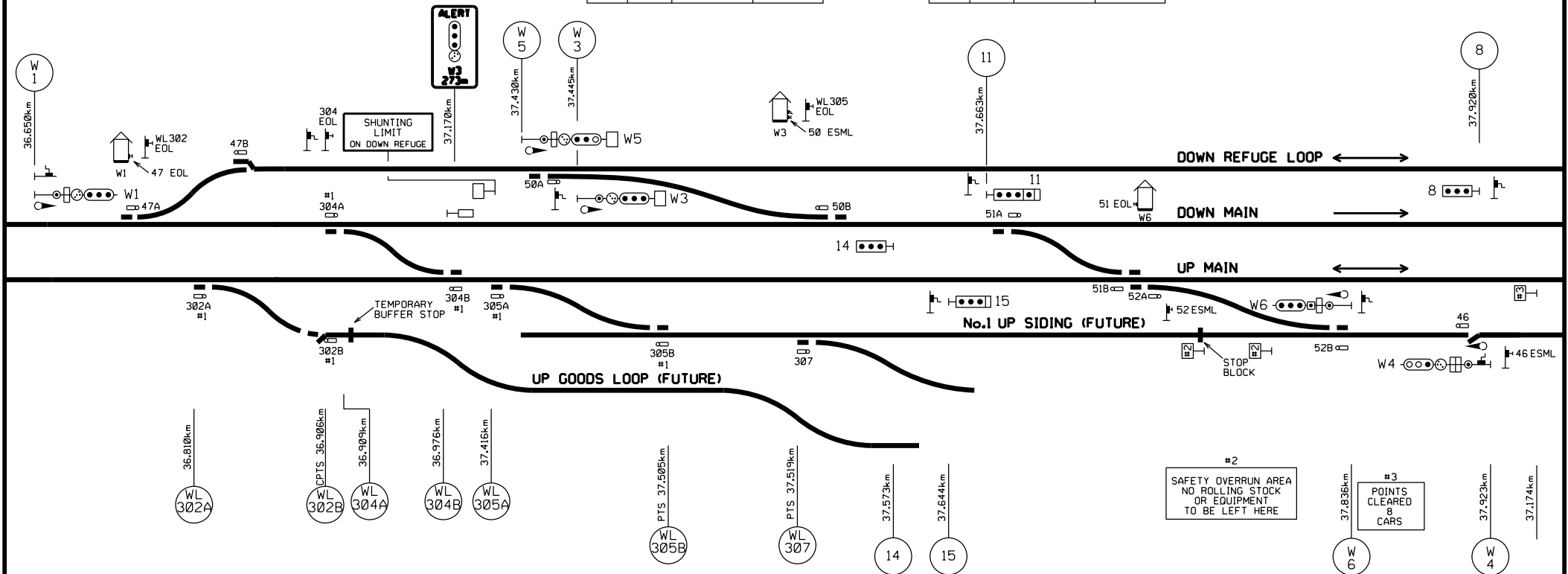

SIGNAL	ROUTE	DESTINATION	INDICATION
<b>15</b>	15A	UP MAIN	U
	15B	UP REFUGE	R
	15C	UP GOODS	G #

# OUT OF USE

SIGNAL	ROUTE	DESTINATION	INDICATION
<b>6</b>	6(M)	UP MAIN	-
	6(S)A	UP MAIN	UM
	6(S)B	DOWN MAIN	DM

SIGNAL	ROUTE	DESTINATION	INDICATION
<b>4</b>	4(S)A	No2 LOCO EXCHANGE SIDING	2L #
	4(S)B	No1 LOCO EXCHANGE SIDING	1L #
	4(S)C	UP MAIN	UM
	4(S)D	DOWN MAIN	DM
	4(M)C	UP MAIN	-

# OUT OF USE

#1 POINTS SPIKED, CLIPPED, XL LOCKED AND DETECTED NORMAL



**WATERFALL**  
 MTMS2 WATERFALL STABLING FACILITY MAY 2022  
 DRIVERS DIAGRAM SHEET 1 OF 2  
 Produced by JMDR  
 VER. 09022022



# WATERFALL

SIGNAL	ROUTE	DESTINATION	INDICATION
9	9A	DOWN MAIN	DM
	9B	UP MAIN	UM
		GREEN LIGHT	• #

# OUT OF USE

SIGNAL	ROUTE	DESTINATION	INDICATION
13	13A	SHUNTING NECK	S
	13B	DOWN MAIN	DM

SIGNAL	ROUTE	DESTINATION	INDICATION
17	17(S)A	SHUNTING NECK	S
	17(S)B	DOWN MAIN	DM

SIGNAL	ROUTE	DESTINATION	INDICATION
19	19(S)A	SHUNTING NECK	S
	19(S)B	DOWN MAIN	DM
	19(S)C	UP MAIN	UM

SIGNAL	ROUTE	DESTINATION	INDICATION
18	18A	DOWN REFUGE	DR
	18B	DOWN SIDING	DS

SIGNAL	ROUTE	DESTINATION	INDICATION
34	34A	UP GOODS	UG #
	34B	UP REFUGE	UR • GREEN LIGHT#

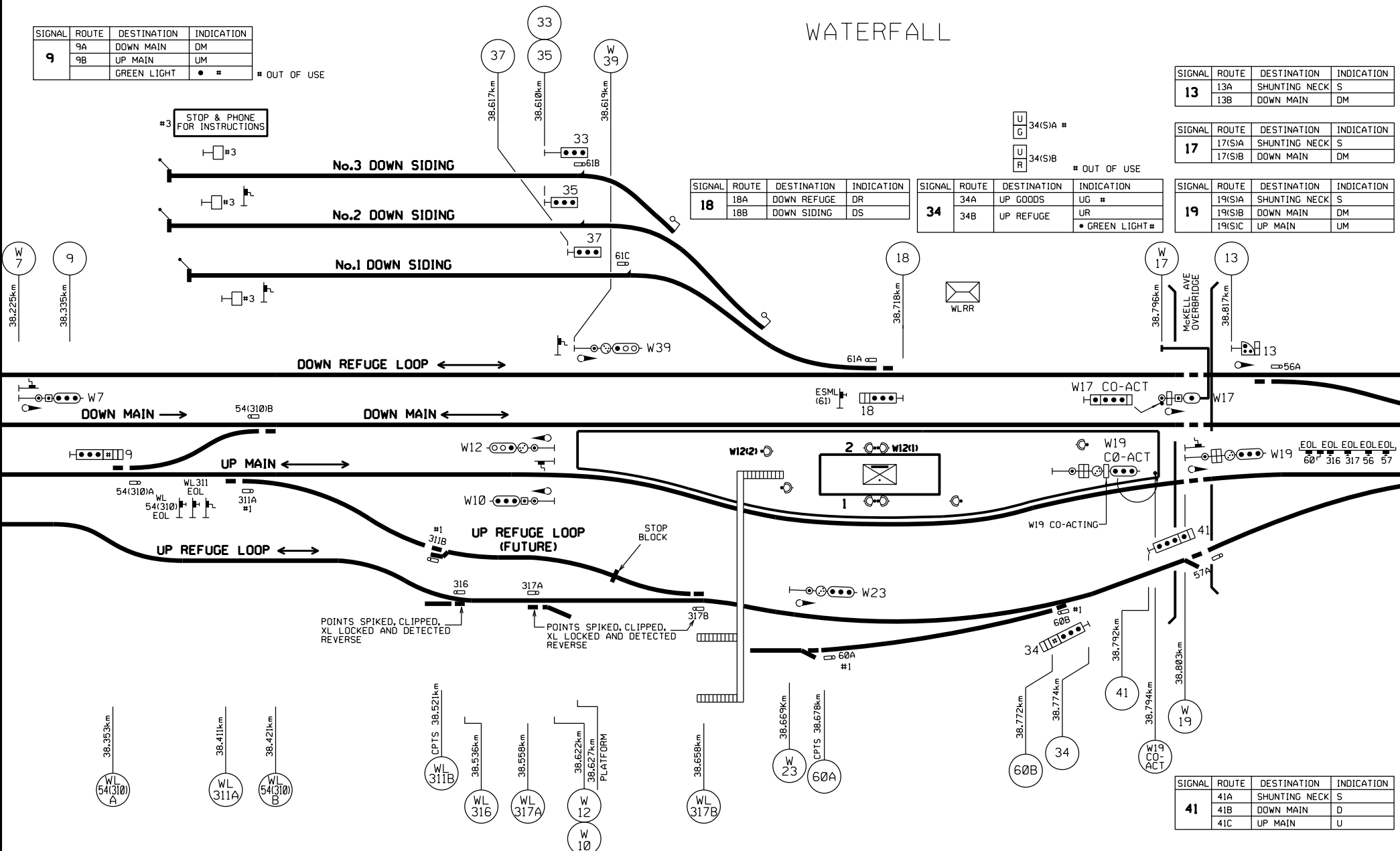

POINTS SPIKED, CLIPPED, XL LOCKED AND DETECTED REVERSE

#1 POINTS SPIKED, CLIPPED, XL LOCKED AND DETECTED NORMAL



**WATERFALL**  
 MTMS2 WATERFALL STABLING FACILITY MAY 2022  
 DRIVERS DIAGRAM SHEET 2 OF 2  
 Produced by JMDR  
 VER. 09022022

JMDR VERSION DATE: 21/04/2022

**BLACKHEATH (WEST) – BLACKHEATH STATION UPGRADE  
PLATFORM PEDESTRIAN CROSSING REMOVAL**

Commencing at 0700 hours on **Saturday, 28 May 2022**, and continuing until 1730 hours on Sunday, 29 May 2022, the following works will be carried out:

- The existing pedestrian crossing at Blackheath Station Platform approximately 120.604km, including LED red man lights, sirens, swing gates and associated signage will be removed and a new fence constructed.
- The Manual Operation and Emergency Switches along with the associated Telephone will be removed from BH PLAT Location.
- The level crossing Warning track side sign “Blackheath Station”, located at approximately 121.223Km, will be removed.
- Signalling arrangements are depicted in the attached diagram

**VER 13042022****Drivers Diagram VER 13042022****Jonathan Maher**

Signalling Commissioning Engineer

JMD Railtech Pty Ltd.,

Mob: 0417 201 543

Email: jonathan.maher@jmdr.com

**Paul Hartley**

Design Delivery Manager

JMD Railtech Pty Ltd.,

Mob: 0447 429 815

Email: paul.hartley@jmdr.com

TO  
KATOOMBA  
←

TO  
MT. VICTORIA  
→

120.500km



# BLACKHEATH

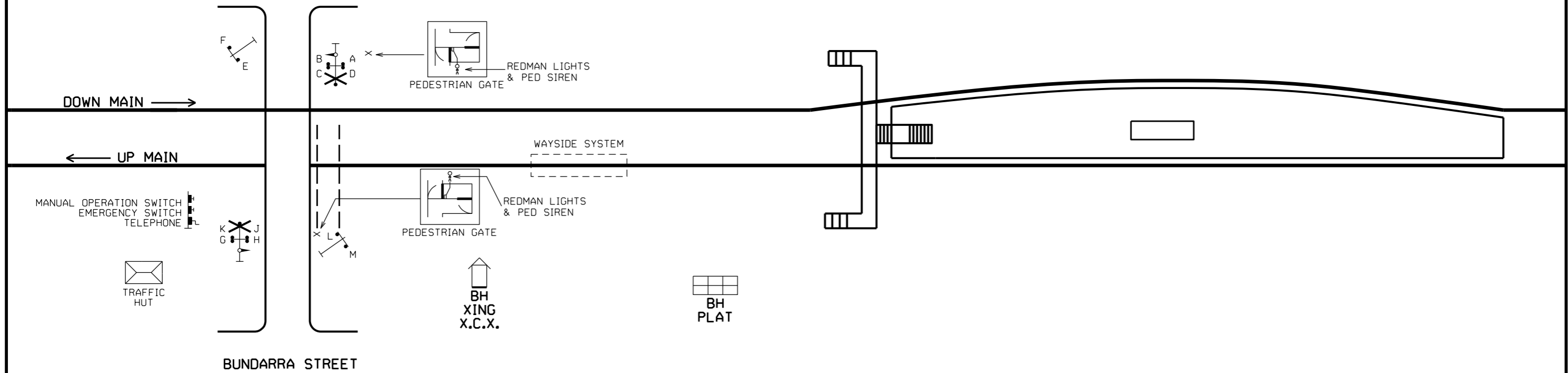

NOT TO SCALE



Transport  
for NSW

## BLACKHEATH STATION UPGRADE

BLACKHEATH PLATFORM PEDESTRIAN CROSSING REMOVAL  
SIGNALLING ARRANGEMENT SHEET 1 OF 2

Produced by JMDR

VER. 13042022

TO  
KATOOMBA  
←

TO  
MT. VICTORIA  
→

121.000km

121.500km

122.000km

122.500km



75  
9

122.090km



76.2  
X.C.X

DOWN MAIN →

← UP MAIN



120.893km

75  
2

BUNDARRA ST  
• 30 sec @ 70 kph  
• 34.6 sec @ 65 kph

XC

STATION  
STREET  
OVERBRIDGE

BLACKHEATH  
SECTION HUT  
BUNDARRA ST  
• 18 sec @ 70 kph  
• 18 sec @ 65 kph

XH  
XTD



BUNDARRA ST



122.677km

76  
2

NOT TO SCALE



Transport  
for NSW

### BLACKHEATH STATION UPGRADE

BLACKHEATH PLATFORM PEDESTRIAN CROSSING REMOVAL  
SIGNALLING ARRANGEMENT SHEET 2 OF 2

Produced by JMDR

VER. 13042022

## **SUTHERLAND – CRONULLA – DIGITAL SYSTEMS PROJECT – ETCS LEVEL 2 BALISES AND SIGNAGE INSTALLATION WORKS**

Commencing 0001 hours on **Saturday, 21 May 2022**, and continuing until 0600 hours on Saturday, 02 July 2022, the following works will be progressively carried out at the Cronulla Branch lines as part of the Digital Systems Program (DSP) Area 1A Sutherland to Cronulla:

- Installation of new Digital Systems Project ETCS Level 2 Balises on the UP Cronulla and DOWN Cronulla Mainlines, Cronulla No.1 and No.2 Platform Roads and Cronulla Sidings 1, 2 and 3. The limits of these installations is from 25.848Km to 35.000Km. All balises will be securely covered with metallic Balise Muting Covers and will not be read by trains.
- Installation of new Digital Systems Project ETCS Level 2 Signage. All new signage will be covered and not be visible to drivers.

This work is required to enable future commissioning of the Digital Systems ETCS Level 2 System. All new signage and balises will remain covered at this stage of the project pending future commissioning.

**VER25032022**

### **Brian Spaul**

Commissioning Engineer, Siemens Digital Systems Project

Mob: 0401 710 457

Email: [synsig@bigpond.com](mailto:synsig@bigpond.com)

### **Victoria Snook**

Engineering Manager, Siemens Digital Systems Project

Mob: 0413 882 534

Email: [victoria.snook@siemens.com](mailto:victoria.snook@siemens.com)

**RHODES TO STANMORE - COMMISSIONING OF AUTOMATIC TRAIN PROTECTION (ATP) ETCS LEVEL 1 LIMITED SUPERVISION**

Commencing at 2300hrs on **Wednesday, 25 May 2022** and continuing until 0400hrs on Thursday, 26 May 2022, TfNSW will commission into use Automatic Train Protection (ATP) ETCS Level 1 Limited Supervision from Main North Lines – Rhodes to Main, Suburban, and Local Lines – Stanmore.

As part of these works the following signage will be brought into use:

<b>Location</b>	<b>Line</b>	<b>Direction</b>	<b>Inscription</b>
<b>MACDONALDTOWN (EXCL) – LEWISHAM (INCL)</b>			
Stanmore at 4.144km	Down Local	Down	BEGIN ATP
Stanmore at 4.144km	Down Local	Up	END ATP
Stanmore at 4.141km	Up Local / Down Suburban	Down	BEGIN ATP
Stanmore at 4.141km	Up Local / Down Suburban	Up	END ATP
Stanmore at 4.135km	Up Suburban / Down Main	Down	BEGIN ATP
Stanmore at 4.135km	Up Suburban / Down Main	Up	END ATP
Stanmore at 4.131km	Up Main	Down	BEGIN ATP
Stanmore at 4.131km	Up Main	Up	END ATP

ATP signage will be as per the Macdonaldtown (Excl) – Lewisham (Incl) Drivers Diagram.

**DIAGRAM VER14032022**

The following signage will be removed:

Location	Line	Direction	Inscription
<b>CONCORD WEST (EXCL) – EASTWOOD (INCL)</b>			
Rhodes at 17.129km	Down Main	Down	BEGIN ATP
Rhodes at 17.129km	Down Main	Up	END ATP
Rhodes at 17.041km	Up Main	Down	BEGIN ATP
Rhodes at 17.041km	Up Main	Up	END ATP

**VER14032022**

**Mark Naylor**

System Integration Project Manager Transport for NSW

Mob: 0431 883 513

Email: mark.naylor@transport.nsw.gov.au

**Brain Spaul**

Signal Commissioning Engineer UGL

Mob: 0401 710 457

Email: emanuel.lavidis@ugllimited.com

**Jesse Crick**

ETCS Commissioning Manager Transport for NSW

Mob: 0408 292 819

Email: jesse.crick@transport.nsw.gov.au

**Immanuel Jegan**

Signalling Design Engineer Rail Systems Australia Mob: 0432 972 207

Email: immanuel.jegan@railsystemsaustralia.com.au

**REGENTS PARK, AUBURN TO STANMORE - COMMISSIONING OF AUTOMATIC TRAIN PROTECTION (ATP) ETCS LEVEL 1 LIMITED SUPERVISION**

Commencing at 0900hrs on **Wednesday, 25 May 2022** and continuing until 0400hrs on Thursday, 26 May 2022, TfNSW will commission into use Automatic Train Protection (ATP) ETCS Level 1 Limited Supervision from Main South Line – Regents Park, Main West and Suburban Lines – Auburn to Main, Suburban, and Local Lines – Stanmore.

As part of these works the following signage will be brought into use:

<b>Location</b>	<b>Line</b>	<b>Direction</b>	<b>Inscription</b>
<b>MACDONALDTOWN (EXCL) – LEWISHAM (INCL)</b>			
Stanmore at 4.144km	Down Local	Down	BEGIN ATP
Stanmore at 4.144km	Down Local	Up	END ATP
Stanmore at 4.141km	Up Local / Down Suburban	Down	BEGIN ATP
Stanmore at 4.141km	Up Local / Down Suburban	Up	END ATP
Stanmore at 4.135km	Up Suburban / Down Main	Down	BEGIN ATP
Stanmore at 4.135km	Up Suburban / Down Main	Up	END ATP
Stanmore at 4.131km	Up Main	Down	BEGIN ATP
Stanmore at 4.131km	Up Main	Up	END ATP

ATP signage will be as per the Macdonaldtown (Excl) – Lewisham (Incl) Drivers Diagram.

**DIAGRAM VER14032022**



The following signage will be removed.

Location	Line	Direction	Inscription
<b>SEFTON PARK (INCL) - CABRAMATTA (EXCL) and LIDCOMBE</b>			
Regents Park at 18.818km	Down Main (South)	Down	BEGIN ATP
Regents Park at 18.818km	Down Main (South)	Up	END ATP
Berala at 18.789km	Up Main (South)	Down	BEGIN ATP
Berala at 18.789km	Up Main (South)	Up	END ATP

Location	Line	Direction	Inscription
<b>AUBURN</b>			
Auburn at 17.793km	Down Main	Down	BEGIN ATP
Auburn at 17.793km	Down Main	Up	END ATP
Auburn at 17.952km	Up Main	Down	BEGIN ATP
Auburn at 17.952km	Up Main	Up	END ATP
Auburn at 17.800km	Down Suburban	Down	BEGIN ATP
Auburn at 17.800km	Down Suburban	Up	END ATP
Auburn at 17.956km	Up Suburban	Down	BEGIN ATP
Auburn at 17.956km	Up Suburban	Up	END ATP

VER14032022

**Mark Naylor**

System Integration Project Manager Transport for NSW

Mob: 0431 883 513

Email: mark.naylor@transport.nsw.gov.au

**Brain Spaul**

Signal Commissioning Engineer UGL

Mob: 0401 710 457

Email: emanuel.lavidis@ugllimited.com

**Jesse Crick**

ETCS Commissioning Manager Transport for NSW

Mob: 0408 292 819

Email: [jesse.crick@transport.nsw.gov.au](mailto:jesse.crick@transport.nsw.gov.au)

**Immanuel Jegan**

Signalling Design Engineer Rail Systems Australia Mob: 0432 972 207

Email: [immanuel.jegan@railsystemsaustralia.com.au](mailto:immanuel.jegan@railsystemsaustralia.com.au)

## **MOUNT VICTORIA (WEST) – MOUNT VICTORIA AREA REMODELLING (MVAR) – UP SIDING MODIFICATION & REMOVALS**

Commencing at 0200 hours on **Monday, 23<sup>rd</sup> May 2022**, and continuing until 00:00 hours on Saturday, 28<sup>th</sup> May 2022, the following works will be carried out:

- Existing signals 35A, 35B, 31, 32, 19B, 19A, 17 & Up Siding No.1 point indicator will be removed
- Existing track circuits on the Up Siding URBT, IRBT, IRCT & IRDT will be removed
- Existing 28/29 Points on the Up Siding will be removed
- 23/26 Points will be clipped & XL locked normal position
- 24/25 Points will be clipped & XL locked in the normal position
- New points MV105B, MV106, MV106, MV107, MV108 & MV109 turnout will be installed in the Up Sidings and will be commissioned at a later date.

### **Rhoel Del Rosario**

Commissioning Manager Signalling  
Major Works – Engineering & Maintenance  
Sydney Trains

Mob: 0413 450 361

Email: [rhoel.delrosario@transport.nsw.gov.au](mailto:rhoel.delrosario@transport.nsw.gov.au)

**FAULCONBRIDGE (WESTERN) – REMOVAL OF BELL TIMER  
AT SIR HENRYS PARADE LEVEL CROSSING**

Commencing at 0200 hours on **Saturday, 28 May 2022**, and continuing until 0200 hours on Monday, 30 May 2022, the following work will be carried out:

- The bell timer that silences the bell between 22:00 and 06:00 will be removed.
- Country side bells will remain suppressed when the boom gates are fully closed.
- Sydney side bells will remain alarmed until the departure of the train.
- All other Controls and indications of the Pedestrian Crossing will remain unchanged.

**VER09112021****Ben Jenkin**

Commissioning Engineer, Signalling  
Project Engineering and Support, Sydney Trains  
Mob: 0419 235 149  
Email: benjamin.jenkin@transport.nsw.gov.au

**Kit Yue**

Signal Design Engineer  
Signal Design, Signalling and Control Systems, Engineering and Systems Integrity  
Tel: 02 8574 2978 (external) 4 2978 (internal)  
Email: kit.yue@transport.nsw.gov.au

**WOLLI CREEK (UP NEW SOUTHERN RAILWAY) – MTMS2  
STAGE 2- INSTALLATION OF NEW UNCOMMISSIONED SR9.6  
AND SR9.8 SIGNALS**

Since 0200 hours on **Saturday, 30 Apr 2022**, and continuing until 0200 hours on Monday, 2 May 2022, the following works will be carried out:

- Installation of new SR9.6 Signal at 9.843KM and bagged out of use (uncommissioned).
- Installation of new SR9.8 Signal at 10.056KM and bagged out of use (uncommissioned).

**VER29032022****DIAGRAM VER29032022****Mark Skribins**

Signalling Commissioning Manager

Mob: +61 412 520 806

Email: mark.skribins@jhg.com.au

**Gerald Chin**

Principal Signalling Engineer

Mob: +61 435 631 133

Email: gerald.chin@wsp.com

**METROPOLITAN FREIGHT LINES – TOC UPDATE & REMOVAL OF SPEED SIGN**

On **Saturday, 21 May 2022**, the up direction X40MU speed sign (for 696 Pts turnout) at 16.050km on the Up Homebush Bay West Fork will be removed and Section 14g of the TOC manual will be updated as follows:

**Section 14g  
Metropolitan Freight Lines  
(including Olympic Park)**

	KILO-MET-RAGE	DOWN		UP	
		Nor-mal	XPT	Nor-mal	XPT
	^14.567	<b>Flemington Gds Jun</b>			
Amend	(1)14.595	..	..	X35	..
to Read	(1)14.595	634A Pts		X35	..
Existing	(1)14.650	35	..	..	..
Existing	(1)14.910	40	..	..	..
Amend	(1)15.390	..	..	40	..
to Read	(1)15.340	..	..	40	..
Amend	(1)15.610	50	..	..	..
to Read	(1)15.650	50	..	..	..
	15.840	<b>Flemington Nth Jun</b>			
Amend	(2)15.850	X30	..	..	..
to Read	(2)15.850	X30	..		863A Pts
Remove	(2)15.880	..	..	X50	..
Existing	(2)16.040	50	..	..	..
Amend	(2)16.920	X50	..	..	..
to Read	(2)16.920	X50	..		870 Pts
Existing	(3)17.230	40	..	..	..
Existing	(4)17.230	40	..	..	..
	17.330	<b>Olympic Park</b>			
Existing	(3)17.640	50	..	..	..
Existing	(4)17.640	50	..	..	..
Amend	(4)17.640	X50	..	..	..
to Read	(4)17.640	X50	..		871 Pts
Insert	(2)19.250	X50	..		862 Pts
	15.840	<b># Flemington Nth Jun</b>			
Amend	(5)15.785#	..	..	X50	..
to Read	(5)15.785#	861B Pts		X50	..
Existing	(6)15.780#	50	..	..	..
Amend	(5)15.530#	..	..	X40	..
to Read	(5)15.530#	860A Pts		X40	..
Amend	(5)14.870#	..	..	50	..

to Read	(5)14.865%	..	..	50	..
Existing	(6)15.050%	40	..	..	..
Existing	(5)15.070%	35	..	..	..
Existing	(5)15.145%	..	..	X40	..
Existing	(5)15.145%	686 Pts	..	X40	..
Amend	(7)15.285%	X35	..	35	..
to Read	(7)15.285%	X35	..	..	687 Pts
Insert	(7)15.275%	..	..	35	..
Existing	(5)15.330%	..	..	40	..
Amend	(6)15.350%	X35	..	X35	..
To Read	(6)15.350%	X35	..	..	689A Pts
Insert	(6)15.350%	687 Pts	..	X35	..
Amend	(8)15.390	..	..	X35	..
To Read	(6)15.390	688 Pts	..	X35	..
Amend	(8)15.490	50	..	..	..
To Read	(6)15.490	50	..	..	..
Amend	(8)15.815	X45	..	50	..
To Read	(6)15.815	..	..	50	..
Amend	(9)15.905	..	..	50	..
To Read	(5)15.905	..	..	50	..
Amend	(9)15.925	X20	..	X40	..
To Read	(5)15.925	X20	..	..	695A Pts
Amend	(8)15.960	X35	X40MU	..	..
To Read	(6)15.960	X35	X40MU	..	697 Pts
<b>16.030 Flemington West Jun</b>					
Amend	(9)16.050	..	..	X35	X40MU
To Read	(5)16.050	696 Pts	..	X35	..
Amend	(8)16.090	X35	X40MU	..	..
To Read	(6)16.090	X35	X40MU	..	701B Pts
<b>Lidcombe Shuttle Road</b>					

- Amend #Km via H'bush Bay East Fork.
- To %Km via H'bush Bay Line.
- Read %Km via H'bush Bay West Fork.
- (1) Homebush Bay East Fork.
- (2) Homebush Bay Loop.
- (3) Inner Platform Road.
- (4) Outer Platform Road.
- (5) Up Homebush Bay West Fork.
- (6) Down Homebush Bay West Fork.
- (7) Homebush Bay connection.
- Remove (8) Down Homebush Bay Line.
- Remove (9) Up Homebush Bay Line.

**Cameron Ly**

Principal Track Design Engineer, Engineering System Integrity

Email: [Cameron.Ly@transport.nsw.gov.au](mailto:Cameron.Ly@transport.nsw.gov.au)

**Jamie Ha**

Designer, Track Design, Engineering System Integrity

Email: [Jamie.ha@transport.nsw.gov.au](mailto:Jamie.ha@transport.nsw.gov.au)



**WOLLONGONG (ILLAWARRA) – MTMS2 WOLLONGONG  
LNIF ENABLING – STAGE 4 FINAL CONFIGURATION OF UP  
AND DOWN YARDS.**

Commencing at 0200 hours on **Saturday, 21 May 2022**, and continuing until 0200 hours on Monday, 23 May 2022, the following works will be carried out:

- The “X25” speed board located at 83.108km in the No1 UP SIDING will be changed to a “25” speed board.

DIAGRAM VER 030522

**Michael Wu**

Project Engineer, Transport for Tomorrow

Tel: +61 437 559 439

Email: [mwu@laingorourke.com.au](mailto:mwu@laingorourke.com.au)

**Shannon Jarvis**

Construction Manager, Transport for Tomorrow

Tel: 0418 607 593

Email: [sjarvis@transfort.com.au](mailto:sjarvis@transfort.com.au)

## STATUS OF TOM NOTICES

<i>Number</i>	<i>Title</i>	<i>Issued</i>	<i>Effective</i>
001 – 2007	Introduction of TOM Notices	13/09/07	13/09/07
018 – 2007	Emergency equipment boxes Rail	01/11/07	19/11/07
010 – 2012	48 Class: Train Operations Manual (TOM)	25/10/12	04/11/12
003 – 2013	48 Class: Wheels	07/02/13	10/02/13
015 – 2013	OMET 200: Minimum Standards for Electric Trains	30/05/13	09/06/13
002 – 2014	OMET 220: Wheelslip light indications	20/02/14	02/03/14
004 – 2016	OMET 262: Failure of Train Management System	14/07/16	24/07/16
001 – 2017	Incorporation of Waratah, Oscar and Millennium TOM Notices and SAFE Notices into the TOM	19/01/17	29/01/17
005 – 2017	TWP 150: Damaged or Missing Window Glass	06/04/17	16/04/17
008 – 2017	TWP 176: Wayside Train Condition Monitoring	06/07/17	16/07/17
004 – 2017	TWP 174 Ice Radio	20/07/17	31/07/17
016 – 2017	WAR 030 Minimum Standards	23/11/17	03/12/17
018 - 2017	Amendment to OMET 200	14/12/17	24/12/17
011 – 2018	Trial of C-Set trains fitted with ATP	19/07/18	29/07/18
012 – 2018	Control Circuit Failure	23/08/18	02/09/18
005 – 2018	OMET 242 Reverser handle jams in forward or reverse	18/08/18	28/08/18
006 – 2018	OMET 250 Applying power from the rear	18/08/18	28/08/18
008 – 2018	TWP 154 Responding to incapacitated Driver/Guard	18/08/18	28/08/18
013 – 2018	Trial of K sets fitted with ATP	17/08/18	27/08/18
016 - 2018	Network Rules Operational standards update	17/08/18	27/08/18
005 – 2019	TWP 106: On Road Performance Assessment	31/01/19	10/02/19
001 – 2019	OMET 266: Operation of Y-set trains	21/02/19	03/03/19
003 - 2019	OMET 264: Minimum Tractive Effort Requirements	21/02/19	03/03/19
012 – 2019	TWP 192: Working Trains Out of service	21/02/19	03/03/19
007 – 2019	TWP 136 Defective wheels	06/03/19	24/03/19
008 – 2019	TWP 190 Automatic Train Protection	06/03/19	24/03/19
009 – 2019	Train crew relieved in service & relay driver	06/03/19	24/03/19
010 – 2019	TWP 152 Disabled trains	06/03/19	24/03/19
011 – 2019	TWP 156: Operating doors	14/03/19	24/03/19
014 – 2019	OSCAR Internal Emergency Door Releases	14/03/19	24/03/19
004 – 2019	TWP 118 Reporting Faults	11/04/19	28/04/19
022 - 2019	Exception to WAR 030 – Minimum Standards	03/10/19	13/10/19
008 - 2020	MOS for TTU Upgraded Tangara trains during testing	20/02/20	01/03/20
004 - 2020	TWP 124 Defective Brakes	20/05/20	08/06/20
005 - 2020	TWP 126 Defective Automatic Brakes	20/05/20	08/06/20
012 - 2020	WAR 202 Bogie Faults	20/05/20	08/06/20
011 - 2020	TWP 162 Train Crew Bell Signals	02/06/20	15/06/20
001 - 2020	Trial of Millennium trains fitted with ATP	12/06/20	21/06/20
014 - 2020	TWP 112 Changing ends	20/07/20	03/08/20

<i>Number</i>	<i>Title</i>	<i>Issued</i>	<i>Effective</i>
017 - 2020	Operating Tangara, OSCAR, Millenium and Waratah with deflated air springs in the city underground	07/12/20	14/12/20
005 - 2021	OMET 254 Topside preparation locations	05/03/21	15/03/21
006 - 2021	TWP 100 Responsibilities of Train Crews	23/03/21	05/04/21
007 - 2021	Operation of H sets fitted with ATP	10/05/21	24/05/21
008 - 2021	Transition (Emergency couplers on OSCAR trains)	14/07/21	26/07/21
011 - 2021	Exception to OMET 200 & 350	17/11/21	29/11/21
001 - 2022	Use of Automatic train Protection in Millennium trains	23/03/22	03/04/22
002 - 2022	Waratah A & B sets fitted with ATP	23/03/22	03/04/22
005 - 2022	TWP 160 Driver procedure at stations	21/04/22	08/05/22

**01** **STATUS OF PERMANENT SAFE NOTICES**

<i>Number</i>	<i>Title</i>	<i>Issued</i>	<i>Effective</i>
003 - 2021	Use of Signal Key Switches	02/12/21	12/12/21
002 - 2021	Introduction of the NIMP	14/10/21	24/10/21

**Steve Swanson**

Network Rules Specialist

Tel: 0428416505

Email: [stephen.swanson@transport.nsw.gov.au](mailto:stephen.swanson@transport.nsw.gov.au)



**STATUS OF NETWORK MANUALS AND FORMS****Network Manuals**

Network Local Appendices	RailSafe Website	Online documents
Operator Specific Procedures	RailSafe Website	Online documents
Network Rules	RailSafe Website	Online documents
Network Procedures	RailSafe Website	Online documents
Forms	RailSafe Website	Online documents (or order as applicable)

<i>Title</i>	<i>Status Sheet</i>	<i>Date issued</i>
<b><i>Train Working Procedures</i></b>		
TWP 100	TN 006 - 2021	April 2021
TWP 102	3	May 2012
TWP 108	4	May 2012
TWP 110	TN 009 - 2019	March 2019
TWP 112	TN 014 - 2020	August 2020
TWP 114	4	November 2015
TWP 116	3	May 2012
TWP 118	TN 004 - 2019	April 2019
TWP 120	3	May 2012
TWP 122	3	May 2012
TWP 124	TN 004 - 2020	May 2019
TWP 126	TN 005 - 2020	May 2019
TWP 128	3	May 2012
TWP 130	3	May 2012
TWP 132	3	May 2012
TWP 134	3	May 2012
TWP 136	TN 007 - 2019	March 2019
TWP 138	4	November 2015
TWP 142	3	May 2012
TWP 144	5	May 2012
TWP 146	3	May 2012
TWP 148	3	May 2012
TWP 150	TN 005 - 2017	April 2017
TWP 152	TN 010 - 2019	March 2019
TWP 154	TN 008 - 2018	July 2018
TWP 156	TN 011 - 2019	March 2019
TWP 158	3	May 2012
TWP 160	TN 005 - 2022	May 2022
TWP 162	TN 011- 2020	May 2019
TWP 164	4	May 2012
TWP 166	3	May 2012
TWP 168	3	May 2012
TWP 170	3	May 2012
TWP 172	4	May 2012
TWP 174	TN 004 - 2017	July 2017
TWP 176	TN 008 - 2017	July 2017
TWP 182	1	November 2015
TWP 184	1	November 2015
TWP 188	1	November 2015
TWP 190	TN 008 - 2019	March 2019
TWP 192	TN 012 - 2019	March 2019

**DISTRIBUTION OFFICERS****Sydney Trains****Safety and Environment****Maria Economou**

Safety Support

 2 4502 2 1840 Maria.Economou@transport.nsw.gov.au**Train Crew Operations****Manager Day of Operations** 8577 7029

TCOManagerDayofOperations@transport.nsw.gov.au

**Train Crewing****Tim Kelly**

Operating Standards Officer

 0422088764 timothy.kelly@transport.nsw.gov.au**Amba Francisco**

Crew Manager – Blacktown/Richmond

 42828 amba.francisco@transport.nsw.gov.au**Anthony Robb**

Crew Area Manager - Flemington

 9536 8844 Anthony.robb@transport.nsw.gov.au**Craig Jackson**

Crew Area Manager - Mortdale

 42624 craig.jackson@transport.nsw.gov.au**Prassanth Indrakumar**



Manager Business Intergration

 69378 prassanth.indrakumar@transport.nsw.gov.au

gov.au

**Patrick Rhymer**



Acting Crew Area Manager - Campbelltown

 91755 patrick.rhymer@transport.nsw.gov.au**Rita Kazzi**



Acting Crew Area Manager Leppington

 63549 rita.kazzi@transport.nsw.gov.au**Rhys Blakey**

Senior Manager Business Enablement

 9224 2044 rhys.blakey@transport.nsw.gov.au**Eric Gardner**

Acting Crew Manager - Penrith

 42893 eric.gardner@transport.nsw.gov.au**Hana Farhat**

Readiness Project Coordinator

 39435 Hana.Farhat2@transport.nsw.gov.au**Andree Porter**

Operations - ROC

 20113 Andree.Porter@transport.nsw.gov.au**Toby Reynolds**

Shift Manager Central

 35982 toby.reynolds@transport.nsw.gov.au**Kerrie-Ann Clarke**

Administration Support Campbelltown

 61725 kerrie-ann.clarke@transport.nsw.gov.au

**Matthew Quinn**

Head of Crew Service Experience Sector 2

 69378 Matthew.Quinn@transport.nsw.gov.au**Mario Chalouhi**

Senior Manager Continuation Training &amp; Competence

 42616 Mario.Chalouhi@transport.nsw.gov.au**Gurdip Singh**

Standards Competency Officer

 0476843447 Gurdip.Singh@transport.nsw.gov.au**Service Delivery Response****Megan Parker**

Service Delivery Response

 0491226502 megan.parker@transport.nsw.gov.au**Leigh Lawton**

Service Delivery Response

 0418237261 leigh.lawton@transport.nsw.gov.au**Maintenance****Fleet Maintenance****Hoshedar Movdawalla**

Fleet Maintenance Sydney Trains

 2 0532  2 1274 HOSHEDAR.MOVDAWALLA@transport.nsw.gov.au**Ram Ramaswamy**

Fleet Maintenance Sydney Trains

 2 0523  2 1274 RAMYAVARAN.RAMASWAMY@transport.nsw.gov.au**Network Maintenance****Zaneta Janevski**

Engineering &amp; Maintenance

 87570199 zaneta.janevski@transport.nsw.gov.au**Shannon Newton**

Track Access Coordinator – North

 95363791 Shannon.Newton@transport.nsw.gov.au**Xerxes Francia**

Track Access Coordinator – North

Hornsby Network Base

 3 6740 Xerxes.Francia@transport.nsw.gov.au**Jonathan Barnes**



Track Access Coordinator – West

Blacktown Network Base

 87512 Jonathan.Barnes@transport.nsw.gov.au**Ennio Soster**

SCE

Project Delivery Electrical

 25236  25917 ENNIO.SOSTER@transport.nsw.gov.au**Daljit Kaur**

Infrastructure Maintenance — Facilities

 2 5922  2 5950 Daljit.Kaur@transport.nsw.gov.au**Adrian Aquilina**

Team leader - Strathfield Mains

 97526610 adrian.aquilina@transport.nsw.gov.au**Christina Morgan**

Administration Support

ICON

 9379 6051 Christina.Morgan@transport.nsw.gov.au





**Lorinda Melvin**

Administration Support

 0439510480 lorinda.melvin@transport.nsw.gov.au**Edward Lusik**

Team Leader Signals

CBD

 95368135 edward.lusik@transport.nsw.gov.au**Major Works****Greg Page**



Infrastructure Track

 25375 gregory.page@transport.nsw.gov.au**Michael Warner**

Signals and Electricity

 9848 9333 michael.warner@transport.nsw.gov.au**Logistics & Supply Chain****Murari Singh**

Contract Assurance Administrator

 02 9848 9698 Murari.Singh@transport.nsw.gov.au**Engineering & System Integrity****Teresa Sitjar**



Signalling &amp; Control Systems

 42458 Teresa.Sitjar@transport.nsw.gov.au**Yass Zahab**

Geotechnical Services

 2 7589  2 7786 Yassine.El-Zahab@transport.nsw.gov.au**Richard Agostino**

C and CS

 2 0875  9 2137 Richard.Agostino@transport.nsw.gov.au**Human Resources****Robert Neloski**



Training — Learning and Development

 2 7567 robert.neloski@transport.nsw.gov.au**Peter Nilon**

Survey Group

 9848 9904 peter.nilon@transport.nsw.gov.au**Trainlink****Phillip Antonioli**



Operational Improvement Manager

 8574 2960 0417694249 Phillip.antonioli@transport.nsw.gov.au**Ashley Brandse**



Associate Director Operations North &amp; Central

 4962 9820 ASHLEY.BRANDSE@transport.nsw.gov.au**Robert Blanch**



Area Manager Hunter &amp; Regional North

 43499210 0458261501 ROBERT.BLANCH@transport.nsw.gov.au**Netti Byrnes**

Area Manager Central Coast

 43499210 0458261501 Annette.Byrnes@transport.nsw.gov.au**Leisa Case**

Area Manager Central Intercity

  0429900371 Annette.Byrnes@transport.nsw.gov.au

**Dwayne Purcell**



Area Manager Central Regional

 0428670580

DWAYNE.PURCELL@transport.nsw.gov.au

**Michael Dorrian**

Area Manager South Coast

  0439743316 Michael.dorrian@transport.nsw.gov.au**Ian Modon**

Area Manager South Main

 0427016255

**NOTES**

**NOTICE TO SUBSCRIBERS**

The Weekly Notice is issued every Tuesday, and takes effect on the following Monday.

Those who require the Weekly Notice must ensure that they receive it and are aware of the changes that affect their work duties and responsibilities.

**Director Safety and Standards**

Sydney Trains

Level 4, 36-46 George Street

Burwood NSW 2134

Tuesday, 03 May 2022