

41

weekly notice

Monday, 08 October 2018
Sunday, 14 October 2018



See online for all Safeworking Information

www.railsafe.org.au

Safeworking information, including Weekly Notices and SAFE Notices, is available on the RailSafe website.

By accessing Weekly Notices and SAFE Notices online, you will receive safety information more quickly. Weekly Notices remain on the RailSafe website for two years; Permanent and Temporary SAFE Notices remain online as long as they are current.

Anyone needing back issues of Weekly Notices and SAFE Notices should contact the Network Rules unit.

If you are outside Sydney Trains, you can reach the RailSafe website via the following address:

www.railsafe.org.au

Other Safeworking documents, such as Network Rules, Network Procedures, Network Local Appendices, Safeworking Policies, SafeTracks flyers, and contractor information are also available online.

**Director Safety and Standards
Sydney Trains**

Continued on next page

CONTENTS

CENTRAL STATION MAIN WORKS – SIGNALLING ENABLING WORKS: RELOCATION OF 195B S UNIT AND REMOVAL OF 205A & 206A TURNOUTS AND STRAIGHT RAILING.	5
MAIN NORTH & NORTH SHORE CORRIDOR WORKS, ECRL/NORTH SHORE SEGREGATION AND HEADWAY IMPROVEMENT ON THE NORTH SHORE LINE - PORTION 1 - EPPING SEGREGATION (DIAGRAM)	6
CENTRAL STATION MAIN WORKS SIGNING ENABLING WORKS – REMOVAL OF 208 CROSSOVER & RELOCATION OF DB1/6 & DB1/9 DISTRIBUTION BOARDS (DIAGRAM)	9
WEST RYDE TO EPPING (NORTH) – LED SIGNAL UPGRADE	10
NORTH SYDNEY – SPEED SIGN CHANGES	11
DUNMORE – SPEED SIGN CHANGES	12
STATUS OF TOM NOTICES	13
STATUS OF PERMANENT SAFE NOTICES	14
STATUS OF NETWORK MANUALS AND FORMS	15
REQUESTS FOR NETWORK MANUALS AND FORMS	17
DISTRIBUTION OFFICERS	18

PUBLICATION DEADLINES AND SUBMISSION OF ARTICLES

Dates of the next four Weekly Notices and deadlines for articles are:

<i>Weekly Notice</i>	<i>For Week</i>	<i>Deadline</i>
42	15/10/2018 – 21/10/2018	18/09/2018
43	22/10/2018 – 28/10/2018	25/09/2018
44	29/10/2018 – 04/11/2018	02/10/2018
45	05/11/2018 – 11/11/2018	09/10/2018

To meet printing and distributing schedules, articles for a Weekly Notice must be received by its deadline.

Articles submitted after a deadline will be published in the next issue of the Weekly Notice. This may result in information not being distributed in time for it to be acted upon.

When submitting articles, please include your name, position title, telephone numbers and email address at the end of the articles as shown below:

Steve Swanson

Network Rules Specialist

Tel: 0428416505

Email: stephen.swanson@transport.nsw.gov.au

CENTRAL STATION MAIN WORKS – SIGNALLING ENABLING WORKS: RELOCATION OF 195B S UNIT AND REMOVAL OF 205A & 206A TURNOUTS AND STRAIGHT RAILING.

Commencing at 0200 hours on **Saturday 20th October 2018**, and continuing until 0200 hours on Monday 22nd October 2018, the following works will be carried out to facilitate construction of the new Metro station box and extension of Platform 9.

- 195B points EP valve unit will be relocated clear of future platform extension works. Cable routes to SY15 and the Track Feeds/Relays in the vicinity will also be re-routed to remain clear of the platform extension footprint.
- Remaining sections of 205A / 206A turnouts removed and straight railed.
- 206 Normal detection is maintained in the interlocking for indication purposes.
- 205B Derailer will be detected in reverse position and 205 Reverse detection is maintained in the interlocking for indication purposes.

VER 12092018

Adam Toffolo

Signalling Commissioning Engineer

Tel: 0416 942 861

Email: adam.toffolo@jmdr.com

Kaniyur Sundareswaran

AGJV Rail Signalling Lead

Tel: +61 439 628 406

Email: k.sundareswaran@aurecongroup.com

MAIN NORTH & NORTH SHORE CORRIDOR WORKS, ECRL/NORTH SHORE SEGREGATION AND HEADWAY IMPROVEMENT ON THE NORTH SHORE LINE - PORTION 1 - EPPING SEGREGATION

Commencing at 0200 hours on **Saturday, 13 October 2018**, and continuing until 0200 hours on Monday, 15 October 2018, the following work will be carried out:

- Complete segregation of ECRL line from the Main North Lines at Epping
- Point 111 on Up Main North Line removed and Point 112 on Down Main North Line spiked, clipped, XL locked in normal position permanently and booked out of use.

Details of the changes to facilitate these works are as follows:

Points

The following points will be altered or removed:

points number	description	remarks
111	Points, Up Main North to Up Chatswood-Epping	Points removed
112	Points, Down Chatswood-Epping to Down Main North	Points booked out of use and permanently clipped, spiked and XL locked in the Normal position

EOLs

The following EOLs will be removed/altered:

EOL number	description	remarks
111	111 EOL, attached to EG44 Bungalow side wall	EOL removed
112	112 EOL, attached to EG44 Bungalow side wall	EOL retained. The SL locks for the point machine, emergency handle cover & EOL will be changed to a Falcon 4 lock to prevent unauthorised operation of the points ensuring equipment is operated safely under Network Rules.

Signals

As a summary, the following signal alterations will be done:

Signal / Route name	km	status	description	ROUTE INDICATOR	remarks
EG249 (M)	24.010	Existing	Down Home, Down Chatswood-Epping to Down Main North		Signal and trainstop removed
EG249 (S)	24.010	Existing	Shunt, Down Chatswood-		Signal and trainstop removed

Signal / Route name	km	status	description	ROUTE INDICATOR	remarks
			Epping to Down Main North		
EG257 (M)	24.010	Existing	Down Home, Up Chatswood-Epping to Up Main North		Signal and trainstop removed
EG257 (S)	24.010	Existing	Shunt, Up Chatswood-Epping to Up Main North		Signal and trainstop removed
EG44 (M)A	24.120	Existing	Up Home, Up Main North to Up Chatswood-Epping		Route removed
EG44 (S)A	24.120	Existing	Shunt, Up Main North to Up Chatswood-Epping	SRI "UC"	Route and route indicator removed
EG44 (M)B	24.120	Existing	Up Home, Up Main North		Top yellow aspect disconnected and blanked. Low speed aspect removed. Route renamed as EG44(M).
EG44 (S)B	24.120	Existing	Shunt, Up Main North	SRI "UM"	Shunt Route Indicator Removed. Route renamed EG44(S).
EG46 (S)A	24.120	Existing	Shunt, Down Main North	SRI "DM"	Shunt Route Indicator Removed. Route renamed as EG46(S).
EG46 (S)C	24.120	Existing	Shunt, Down Main North to Down Chatswood-Epping	SRI "DC"	Route & Shunt Route Indicator removed
EG54(M)	24.700	Existing	Up Home, Up Main North		Left hand turnout repeater removed
EG60	25.184	Existing	Up Outer Home, Up Main North		Left hand turnout repeater removed
EG62	26.085	Existing	Up Outer Home, Up Main North		Left hand turnout repeater removed

Signalling works on Main North Lines

A new Stop Block will be positioned at 112 points to protect against any unauthorised movements from the Main Line, whilst also providing supplementary protection from unauthorised movements from the ECRL tunnel.

A new no wire board will be installed on Down Main North Line on 112 points.

A new Buffer Stop will be installed within the NRT area limits to be the primary form of protection for unauthorised movements from the tunnel.

ECRL Epping interface works

As a summary, the following signal alterations will be done:

Signal / Route name	km	status	description	ROUTE INDICATOR	remarks
EG233D	25.225	Existing	Down Outer Home, Down Chatswood-Epping		Signal and trainstop removed
EG235U	25.209	Existing	Down Outer Home, Up Chatswood-Epping		Signal and trainstop removed
EG236U	25.300	Existing	Up Outer Home, Up Chatswood-Epping		Signal and trainstop removed, co-acting signal removed

Intermediate trainstops, 44 ITS(1) & 44 ITS(2) at 25.368km & 25.434km on Up Chatswood – Epping line will be removed

Existing speed sign of X60 kmph at 24.100km on Up Main North will be removed.

ATRICS

ATRICS Epping Panel will be updated to reflect changes at Epping.

ATRICS North Shore Panel will be updated to reflect the removed Chatswood infrastructure of WE14.

The new arrangements are depicted in the attached Signalling Arrangement diagram.

Signalling Arrangement VER 08062018

Philip Meurant

Signal Commissioning Engineer
 Mob: 0419 181 888
 Email: pmeurant@laingorourke.com.au

Saraswathi Penneru

Senior Signal Engineer
 Engineering Signal Design
 Mob: 0448 724 702
 Email: Saraswathi.penneru@wsp.com

TO SYDNEY



22.500Km



TO HORNSBY



23.000Km



22.531km

N13.87B



- EG 25
- EG 27
- N 14.20
- NS 14.20

22.861km

SIGNAL	DESCRIPTION	RTE IND
25(M)	DN SUBURBAN	
25(S)	DN SUBURBAN	

SIGNAL	DESCRIPTION	RTE IND
27(M)A	DN SUBURBAN	
27(M)B	DN MAIN	
27(S)A	DN SUBURBAN	DS
27(S)B	DN MAIN	DM

27(S)
A DS DM B

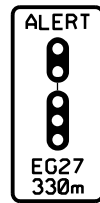

ALDRIDGE LED

DOWN SIDING

25(S) 25(M)

DOWN SUBURBAN →

27(S) 27(M)A 27(M)B

DOWN MAIN →

FROM SYDNEY VIA STRATHFIELD

← UP MAIN

N14.20

← UP SUBURBAN

N14.20 XCX NS14.20



MAIN NORTH & NORTH SHORE CORRIDOR WORKS
PART SIGNALLING ARRANGEMENT
PORTION 1, EPPING SEGREGATION FINAL
SHEET 1 OF 7

Produced by WSP - Signal Design

WN 41 & WN 42 VER08062018

TO SYDNEY

TO HORNSBY

EMERGENCY OPERATION LOCK

MOUNTED IN CUPBOARD, RELEASES KEY FOR POINTS MOTOR SECURED WITH S.L. LOCK

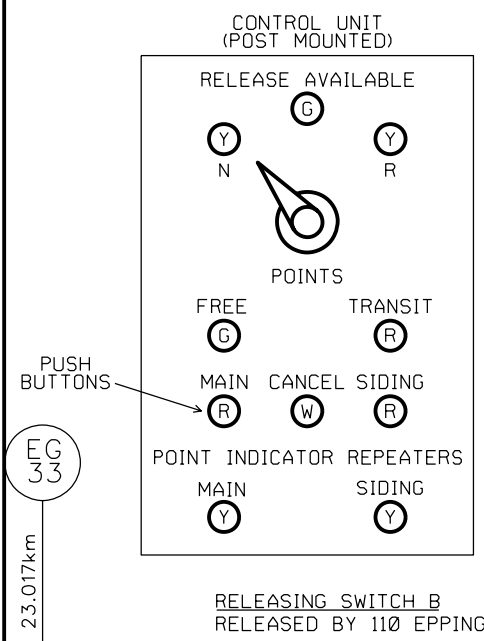
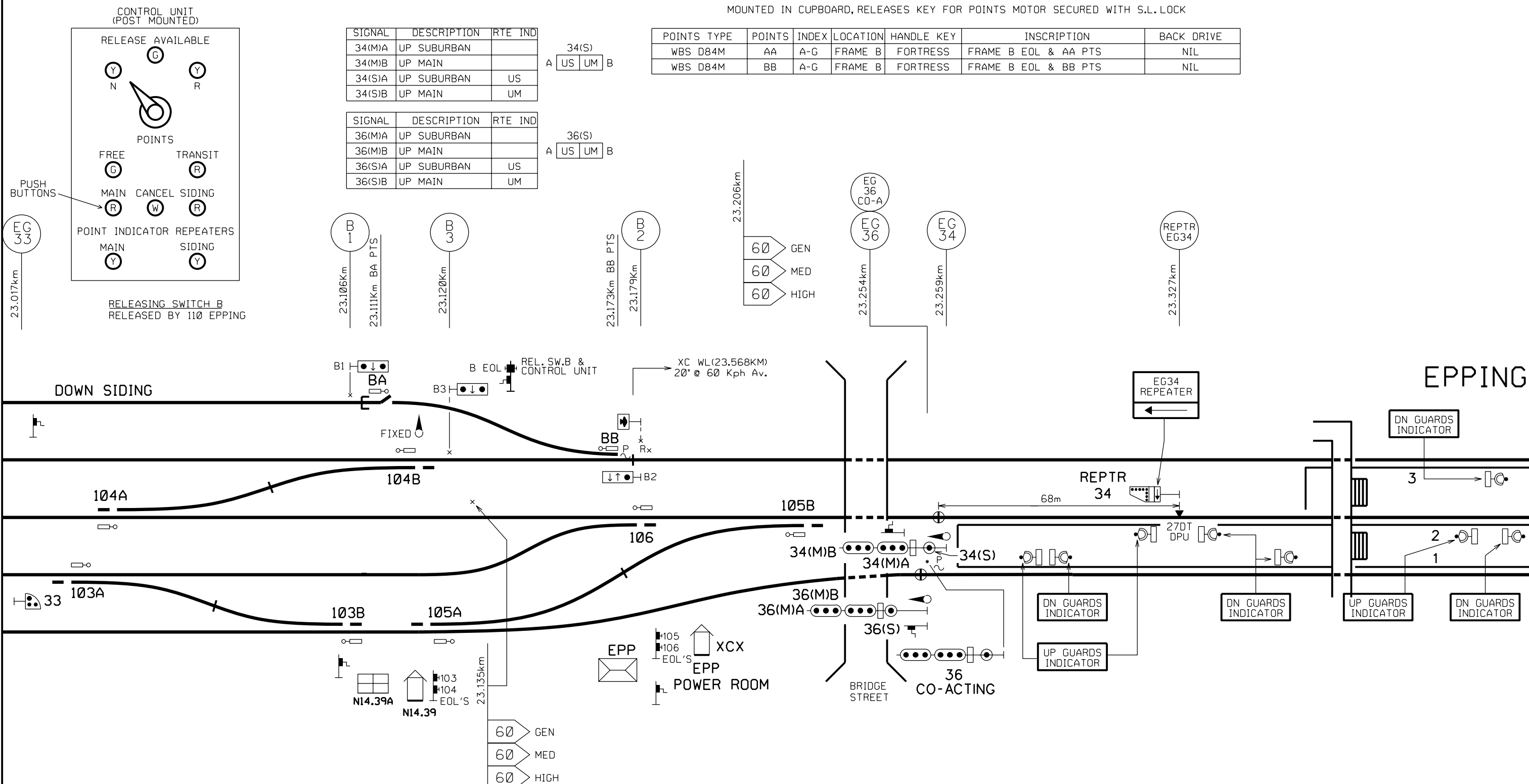

SIGNAL	DESCRIPTION	RTE IND
34(M)A	UP SUBURBAN	
34(M)B	UP MAIN	
34(S)A	UP SUBURBAN	US
34(S)B	UP MAIN	UM

SIGNAL	DESCRIPTION	RTE IND
36(M)A	UP SUBURBAN	
36(M)B	UP MAIN	
36(S)A	UP SUBURBAN	US
36(S)B	UP MAIN	UM

POINTS TYPE	POINTS	INDEX	LOCATION	HANDLE KEY	INSCRIPTION	BACK DRIVE
WBS D84M	AA	A-G	FRAME B	FORTRESS	FRAME B EOL & AA PTS	NIL
WBS D84M	BB	A-G	FRAME B	FORTRESS	FRAME B EOL & BB PTS	NIL

EMERGENCY OPERATION LOCK
MOUNTED IN CUPBOARD, RELEASES KEY FOR POINTS MOTOR SECURED WITH S.L. LOCK

POINTS TYPE	POINTS	INDEX	LOCATION	HANDLE KEY	INSCRIPTION	BACK DRIVE
WBS D84M MKIII	103A	A-L	EPP	FORTRESS	EPPING EOL & 103A PTS MOTOR	NIL
WBS D84M MKIII	103B	A-L	EPP	FORTRESS	EPPING EOL & 103B PTS MOTOR	NIL
WBS D84M MKIII	104A	A-F	EPP	FORTRESS	EPPING EOL & 104A PTS MOTOR	NIL
WBS D84M MKIII	104B	A-F	EPP	FORTRESS	EPPING EOL & 104B PTS MOTOR	NIL
WBS D84M MKIII	105A	A-H	EPP	FORTRESS	EPPING EOL & 105A PTS MOTOR	NIL
WBS D84M MKIII	105B	A-H	EPP	FORTRESS	EPPING EOL & 105B PTS MOTOR	NIL
WBS D84M MKIII	106	A-K	EPP	FORTRESS	EPPING EOL & 106 PTS MOTOR	NIL

MAIN NORTH & NORTH SHORE CORRIDOR WORKS
PART SIGNALLING ARRANGEMENT
PORTION 1, EPPING SEGREGATION FINAL
SHEET 2 OF 7
Produced by WSP - Signal Design WN 41 & WN 42 VER08062018

TO SYDNEY
←

23.500km



TO HORNSBY
→

SECTIONING HUT

SIGNAL	DESCRIPTION	RTE IND
43(M)	DN MAIN	
43(S)	DN MAIN	

SIGNAL	DESCRIPTION	RTE IND
45(M)	DN MAIN	
45(S)	DN MAIN	

SIGNAL	DESCRIPTION	RTE IND
39(M)A	DN MAIN	
39(S)A	DN MAIN	DM
39(S)B	UP MAIN	UM
39(S)C	TURNBACK SIDING	TS

39(S)	
DM	UM
TS	

SIGNAL	DESCRIPTION	RTE IND
41(M)A	UP MAIN	
41(S)A	UP MAIN	UM
41(S)B	TURNBACK SIDING	TS

41(S)	
UM	TS

SIGNAL	DESCRIPTION	RTE IND	TYPE
37(M)A	DN RELIEF	R	MLRI
37(M)B	DN SUBURBAN	S	MLRI
37(S)A	DN RELIEF	DR	SRI
37(S)B	DN SUBURBAN	DS	SRI

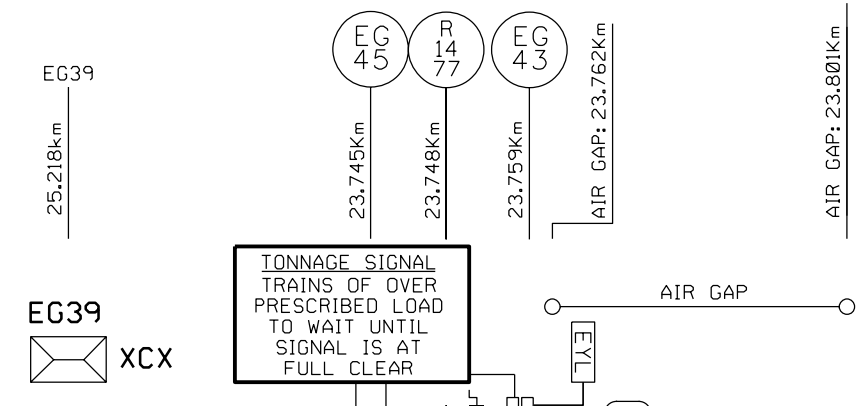
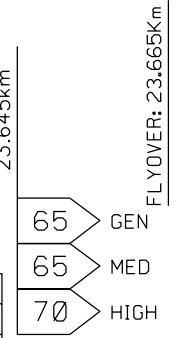

EPPING

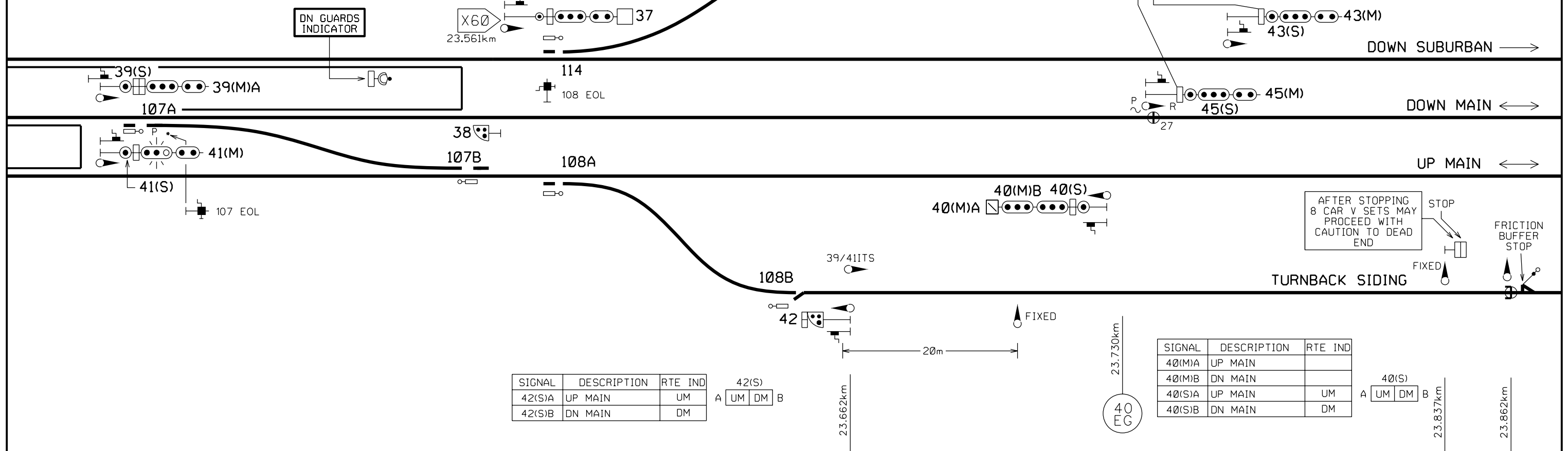

EMERGENCY OPERATION LOCK
MOUNTED IN CUPBOARD, RELEASES KEY FOR POINTS MOTOR SECURED WITH S.L. LOCK

POINTS	TYPE	POINTS	INDEX	LOCATION	HANDLE KEY	INSCRIPTION	BACK DRIVE
WBS D84M	107A	A-E	EG 39	FORTRESS	EPPING EOL & 107A PTS MOTOR	NIL	
WBS D84M	107B	A-E	EG 39	FORTRESS	EPPING EOL & 107B PTS MOTOR	NIL	
WBS D84M	108A	A-D	EG 39	FORTRESS	EPPING EOL & 108A PTS MOTOR	NIL	
WBS D84M	108B	A-D	EG 39	FORTRESS	EPPING EOL & 108B PTS MOTOR	NIL	
WBS D84M	114	A-H	EG 39	FORTRESS	EPPING EOL & 114 PTS MOTOR	1 BACK DRIVE	

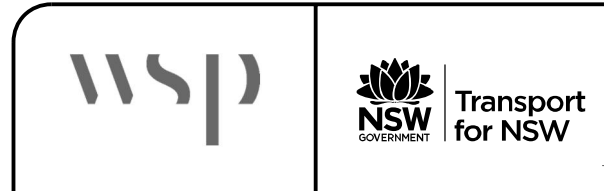

MAIN NORTH & NORTH SHORE CORRIDOR WORKS
PART SIGNALLING ARRANGEMENT
PORTION 1, EPPING SEGREGATION FINAL
SHEET 3 OF 7
Produced by WSP - Signal Design WN 41 & WN 42 VER08062018

TO SYDNEY



TO HORNSBY



24.000Km



SIGNAL	DESCRIPTION	RTE IND
47(M)	DN MAIN	
47(S)	DN MAIN	

SIGNAL	DESCRIPTION	RTE IND
49(M)	UP MAIN	
49(S)	UP MAIN	

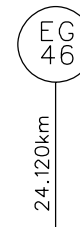
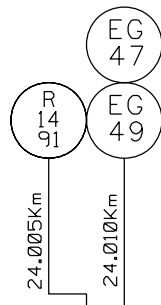

FLYOVER: 23.922km

UNDERBRIDGE: 24.299km



DOWN RELIEF →

NRT ← SYDNEY TRAINS →

DOWN SUBURBAN →

NRT LINE

STOP BLOCK

DOWN MAIN ↔

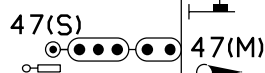

*2 112

UP MAIN ↔

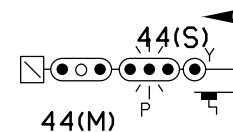
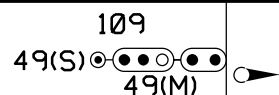

SIGNAL	DESCRIPTION	RTE IND
44(M)	UP MAIN	
44(S)	UP MAIN	

EMERGENCY OPERATION LOCK

MOUNTED IN CUPBOARD, RELEASES KEY FOR POINTS MOTOR SECURED WITH S.L. LOCK

POINTS TYPE	POINTS	INDEX	LOCATION	HANDLE KEY	INSCRIPTION	BACK DRIVE
WBS D84M	109	A-J	EG 44	FORTRESS	EPPING EOL & 109 PTS MOTOR	NIL
WBS D84M	112	A-K	EG 44	FORTRESS	EPPING EOL & 112 PTS MOTOR	1 SPRING ASSIST

24.120km
EG 44

SIGNAL	DESCRIPTION	RTE IND
46(S)	DN MAIN	

***2 - POINT 112 BOOKED OUT OF USE
CLIPPED, SPIKED & XL LOCKED IN NORMAL POSITION**



MAIN NORTH & NORTH SHORE CORRIDOR WORKS
PART SIGNALLING ARRANGEMENT
PORTION 1, EPPING SEGREGATION FINAL
SHEET 4 OF 7

TO SYDNEY



TO HORNSBY



24.500Km



UNDERBRIDGE: 24.436Km

R15.27

24.555Km

EG 51

EG 53

24.575Km

24.595Km

70 GEN
70 MED
90 HIGH

SIGNAL	DESCRIPTION	RTE IND
51(M)	DN MAIN	
51(S)	DN MAIN	

SIGNAL	DESCRIPTION	RTE IND
53(M)A	DN MAIN	
53(S)A	DN MAIN	

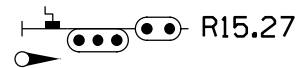

DOWN RELIEF →

DOWN MAIN ↔

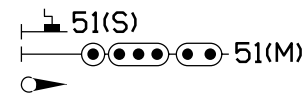

DOWN MAIN ↔

UP MAIN ↔



← UP MAIN

M2 UNDERPASS



EG51

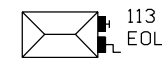

24.700Km

EG 54

EG 56

SIGNAL	DESCRIPTION	RTE IND
54(M)	UP MAIN	
54(S)	UP MAIN	

SIGNAL	DESCRIPTION	RTE IND
56(S)A	UP MAIN	UM
56(S)B	DN MAIN	DM

A UM DM B

EMERGENCY OPERATION LOCK

MOUNTED IN CUPBOARD, RELEASES KEY FOR POINTS MOTOR SECURED WITH S.L. LOCK

POINTS TYPE	POINTS	INDEX	LOCATION	HANDLE KEY	INSCRIPTION	BACK DRIVE
WBS D84M	113A	A-M	EG 51	FORTRESS	EPPING EOL & 113A PTS MOTOR	1 BACK DRIVE
WBS D84M	113B	A-M	EG 51	FORTRESS	EPPING EOL & 113B PTS MOTOR	1 BACK DRIVE



MAIN NORTH & NORTH SHORE CORRIDOR WORKS
PART SIGNALLING ARRANGEMENT
PORTION 1, EPPING SEGREGATION FINAL
SHEET 5 OF 7

TO SYDNEY

TO HORNSBY

25.000Km

25.500Km

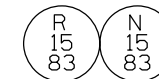
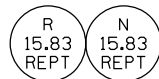
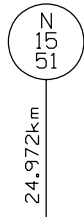
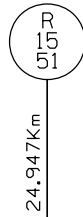
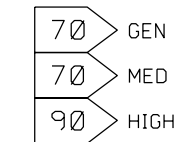
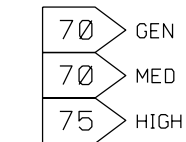
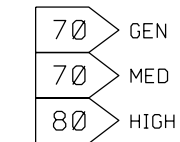

CHELTENHAM

BEECROFT SUBSTATION

XC WL(25.479km) 23' @ 79 Kph Av.



DOWN RELIEF →



WHEN THIS SIGNAL IS AT STOP WAIT ONE MINUTE AND THEN PROCEED CAUTIOUSLY TO NEXT SIGNAL

N15.83 REPT

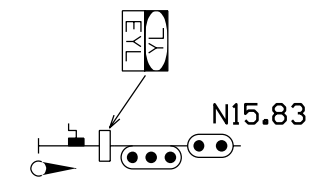
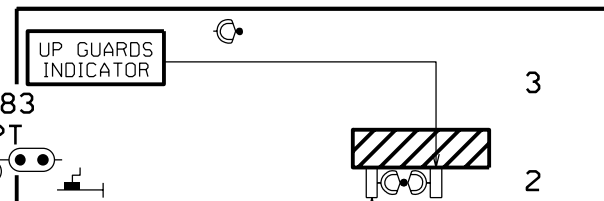

56 REPT

DN GUARDS INDICATOR

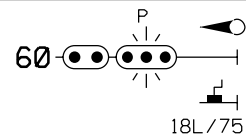
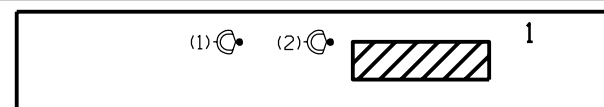

18L/75



THIS SIGNAL MUST NOT BE PASSED AT STOP WITHOUT AUTHORITY FROM SIGNALLER

EG60 POWER ROOM

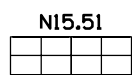

24.995km

25.180km

25.184km



CHELTENHAM ROAD



MAIN NORTH & NORTH SHORE CORRIDOR WORKS
 PART SIGNALLING ARRANGEMENT
 PORTION 1, EPPING SEGREGATION FINAL
 SHEET 6 OF 7

Produced by WSP - Signal Design

WN 41 & WN 42 VER08062018

TO SYDNEY



TO HORNSBY



26.000Km



26.500Km



AIR GAP: 25.802Km

N15.83B

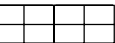

25.848Km

AIR GAP: 25.862Km

AIR GAP

XC WL(26.725KM)
41' @ 75 Kph Av.

N16.00

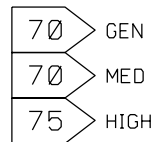

26.313km

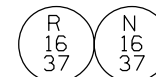

26.353km

26.372km

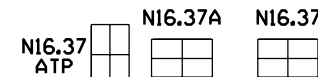

TO HORNSBY

DOWN MAIN →

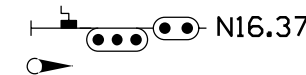

↔ UP MAIN

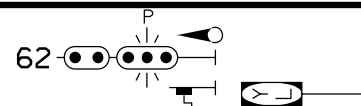

26.085km



MAIN NORTH & NORTH SHORE CORRIDOR WORKS
PART SIGNALLING ARRANGEMENT
PORTION 1, EPPING SEGREGATION FINAL
SHEET 7 OF 7

CENTRAL STATION MAIN WORKS SIGNING ENABLING WORKS – REMOVAL OF 208 CROSSOVER & RELOCATION OF DB1/6 & DB1/9 DISTRIBUTION BOARDS

Since **Monday 17 September 2018**, the following works were carried out to facilitate construction of the new metro station box;

- Location cases DB1/6 & DB1/9 were removed and a new combined Location Case DB1/9 was installed at the end of platforms 10/11, 5 metres country side from the current location of DB1/9, allowing for extension of the platforms.
- The remaining section of crossover 208A/B will be removed, including plain lining of 208A switches. Normal detection will be maintained for indication purposes.

The new arrangement is shown in the attached Drivers Diagram.

VER 04092018
DRIVERS DIAGRAM VER 04092018

Adam Toffolo
Signalling Commissioning Engineer
Tel: 0416 942861
Email: adam.toffolo@jmdr.com

Kaniyur Sundareswaran
AGJV Rail Signalling Lead
Tel: 0439 6 28 406
Email: k.sundareswaran@aurecongroup.com

#2 DERAILER IN REVERSE POSITION AND BOOKED OUT OF USE.

#3 DB1/6 AND DB1/9 LOCATIONS RELOCATED AND INTEGRATED INTO NEW DB1/9 LOCATION.

SYDNEY TERMINAL CONCOURSE

NOTE: PLATFORM 13 AND 14 ARE OUT OF USE TEMPORARILY AND HOARDING ERECTED ON ISLAND PLATFORM 12/13 TO SEGREGATE METRO BOX CONSTRUCTION ZONE.

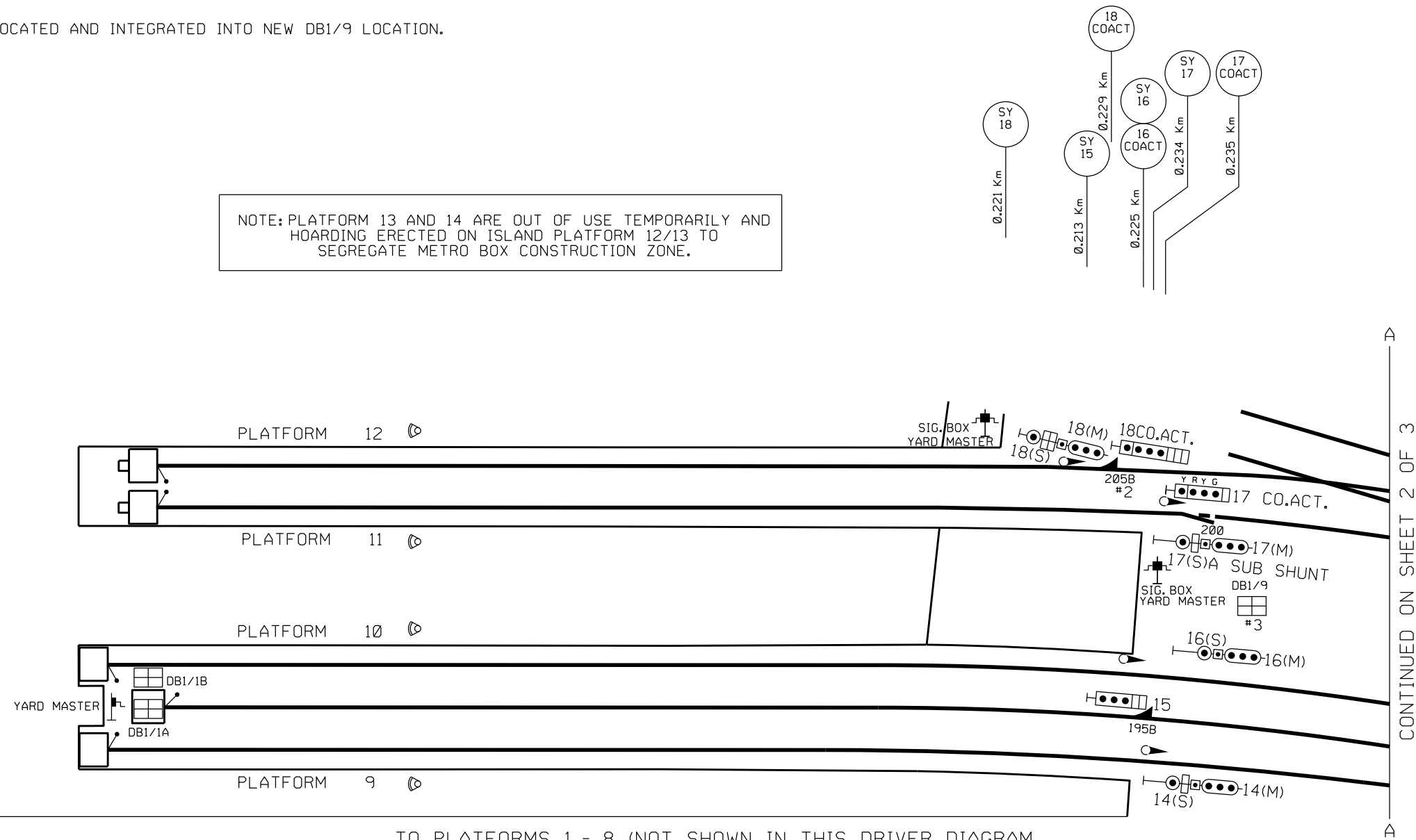

TO PLATFORMS 1 - 8 (NOT SHOWN IN THIS DRIVER DIAGRAM)

SIGNAL	ROUTE	DESTINATION	IND.	TYPE
14	14(M)A	DOWN BANKSTOWN	-	-
	14(S)A	DOWN BANKSTOWN	DB	STENCIL
	14(S)B	UP BANKSTOWN	UB	STENCIL

SIGNAL	ROUTE	DESTINATION	IND.	TYPE
15	15(S)A	DOWN BANKSTOWN	DB	STENCIL
	15(S)B	UP BANKSTOWN	UB	STENCIL

SIGNAL	ROUTE	DESTINATION	IND.	TYPE
17	17(M)	DOWN BANKSTOWN	-	-
	17(S)A	DOWN BANKSTOWN	DB	STENCIL
	17(S)B	UP BANKSTOWN	UB	STENCIL

SIGNAL	ROUTE	DESTINATION	IND.	TYPE
18	M	DOWN BANKSTOWN	-	-
	18(S)B	DOWN BANKSTOWN	DB	STENCIL
	18(S)C	UP BANKSTOWN	UB	STENCIL

SIGNAL	ROUTE	DESTINATION	IND.	TYPE
18 CO.ACT.	M	DOWN BANKSTOWN	-	-
	18(S)B	DOWN BANKSTOWN	DB	STENCIL
	18(S)C	UP BANKSTOWN	UB	STENCIL

SIGNAL	ROUTE	DESTINATION	IND.	TYPE
17 CO.ACT.	17(M)	DOWN BANKSTOWN	-	-
	17(S)A	DOWN BANKSTOWN	D	MMLRI
	17(S)B	UP BANKSTOWN	U	MMLRI



SYDNEY YARD

SIGNALLING ARRANGEMENT SHEET 1 OF 3

PRODUCED BY AGJV FOR SYDNEY METRO-SIGNALLING TEAM
WN37 15/16 SEPTEMBER 2018
VER: 04092018

#1 SPIKED, CLIPPED, XL LOCKED & DETECTED IN REVERSE POSITION.

#2 SPIKED, CLIPPED, XL LOCKED & DETECTED IN NORMAL POSITION.

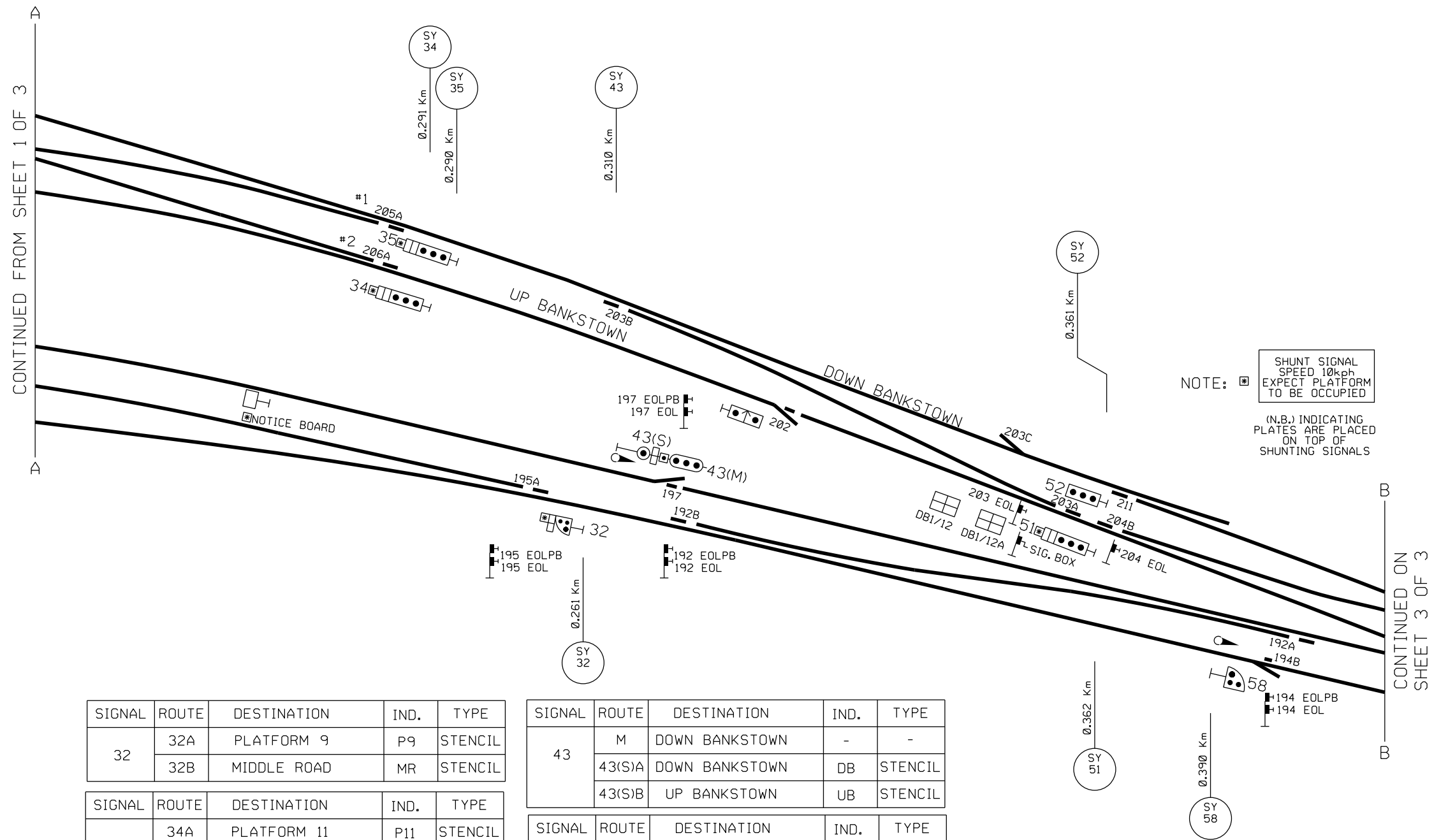

NOTE: SHUNT SIGNAL
SPEED 10kph
EXPECT PLATFORM
TO BE OCCUPIED

(N.B.) INDICATING
PLATES ARE PLACED
ON TOP OF
SHUNTING SIGNALS

SIGNAL	ROUTE	DESTINATION	IND.	TYPE
32	32A	PLATFORM 9	P9	STENCIL
	32B	MIDDLE ROAD	MR	STENCIL

SIGNAL	ROUTE	DESTINATION	IND.	TYPE
34	34A	PLATFORM 11	P11	STENCIL
	34B	BOOKED OUT OF USE	P13	STENCIL

SIGNAL	ROUTE	DESTINATION	IND.	TYPE
35	35A	PLATFORM 12	P12	STENCIL
	35B	BOOKED OUT OF USE	P14	STENCIL

SIGNAL	ROUTE	DESTINATION	IND.	TYPE
43	M	DOWN BANKSTOWN	-	-
	43(S)A	DOWN BANKSTOWN	DB	STENCIL
	43(S)B	UP BANKSTOWN	UB	STENCIL

SIGNAL	ROUTE	DESTINATION	IND.	TYPE
51	51A	PLATFORM 11	11	MMLRI
	51B	PLATFORM 14	14	MMLRI



SYDNEY YARD

SIGNALLING ARRANGEMENT SHEET 2 OF 3
 PRODUCED BY AGJV FOR SYDNEY METRO-SIGNALLING TEAM
 WN37 15/16 SEPTEMBER 2018 VER: 04092018

SIGNAL	ROUTE	DESTINATION	IND.	TYPE
59	59A	PLATFORM 11	11	STENCIL
	59B	PLATFORM 14	12	STENCIL

SIGNAL	ROUTE	DESTINATION	IND.	TYPE
68	68(M)A	DOWN SUBURBAN	-	-
	68(M)B	DOWN MAIN	M	MLRI
	68(S)A	DOWN SUBURBAN	DS	STENCIL
	68(S)B	UP SUBURBAN	US	STENCIL
	68(S)C	DOWN MAIN	DM	STENCIL
	68(S)D	UP MAIN	UM	STENCIL

SIGNAL	ROUTE	DESTINATION	IND.	TYPE
74	74(M)A	PLATFORM 9	9	MLRI
	74(M)B	PLATFORM 10	10	MLRI
	74(M)C	PLATFORM 11	11	MLRI
	74(M)D	PLATFORM 12	12	MLRI
	74(M)E	BOOKED OUT OF USE	13	MLRI
	74(M)F	BOOKED OUT OF USE	14	MLRI
	74(S)A	PLATFORM 9	9	STENCIL
	74(S)B	PLATFORM 10	10	STENCIL
	74(S)C	PLATFORM 11	11	STENCIL

SIGNAL	ROUTE	DESTINATION	IND.	TYPE
75	75X	PLATFORM 9	9	MMLRI
	75A	PLATFORM 10	10	MMLRI
	75B	PLATFORM 12	14	MMLRI

SIGNAL	ROUTE	DESTINATION	IND.	TYPE
79	79A	UP BANKSTOWN	U	MMLRI(UP)
			B	MMLRI(LOW)
	79B	UP SUBURBAN	U	MMLRI(UP)
			S	MMLRI(LOW)
	79D	UP MAIN	U	MMLRI(UP)
			M	MMLRI(LOW)

SIGNAL	ROUTE	DESTINATION	IND.	TYPE
73	73A	PLATFORM 6	P6	STENCIL
	73B	PLATFORM 8	P8	STENCIL

SIGNAL	ROUTE	DESTINATION	IND.	TYPE
69	69(M)B	DOWN MAIN	M	MLRI
	69(S)A	DOWN BANKSTOWN	DB	STENCIL
	69(S)B	DOWN SUBURBAN	DS	STENCIL
	69(S)C	DOWN MAIN	DM	STENCIL

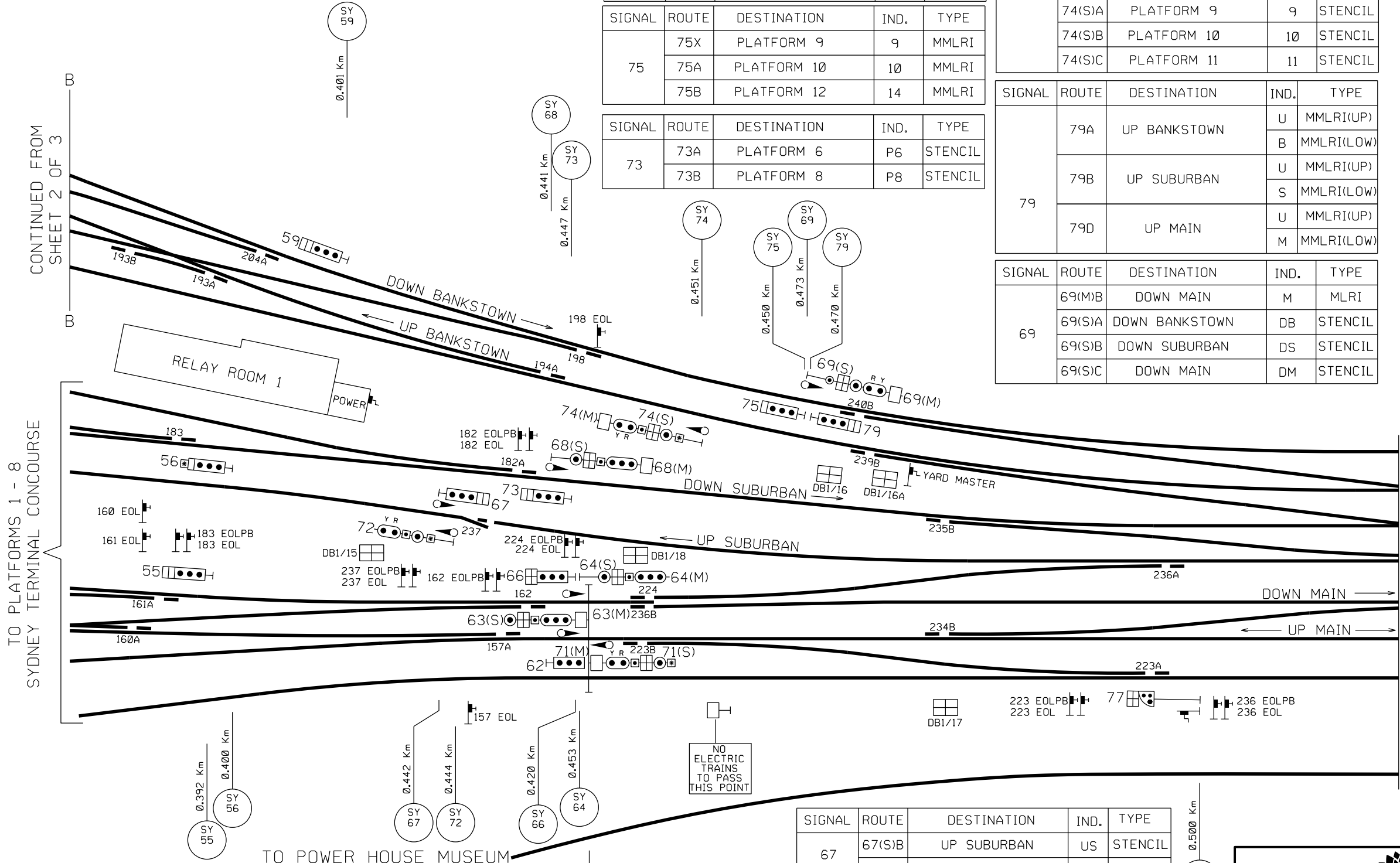

CONTINUED FROM SHEET 2 OF 3

TO PLATFORMS 1 - 8 SYDNEY TERMINAL CONCOURSE

FOR CONTINUATION REFER TO SYDNEY YARD SIGNALLING PLAN

TO POWER HOUSE MUSEUM

NO ELECTRIC TRAINS TO PASS THIS POINT

SIGNAL	ROUTE	DESTINATION	IND.	TYPE
63	63(M)A	DOWN MAIN	D	MLRI
	63(M)B	UP MAIN	U	MLRI
	63(S)B	DOWN MAIN	DM	STENCIL
	63(S)C	UP MAIN	UM	STENCIL
	63(S)D	UP SHUNTING NECK	SN	STENCIL

SIGNAL	ROUTE	DESTINATION	IND.	TYPE
67	67(S)B	UP SUBURBAN	US	STENCIL
	67(S)D	UP MAIN	UM	STENCIL

SIGNAL	ROUTE	DESTINATION	IND.	TYPE
64	M	DOWN MAIN	-	-
	64(S)A	BOOKED OUT OF USE	US	STENCIL
	64(S)B	BOOKED OUT OF USE	DM	STENCIL
	64(S)C	BOOKED OUT OF USE	UM	STENCIL



SYDNEY YARD
 SIGNALLING ARRANGEMENT SHEET 3 OF 3
 PRODUCED BY AGJV FOR SYDNEY METRO-SIGNALLING TEAM
 WN37 15/16 SEPTEMBER 2018
 VER: 04092018

WEST RYDE TO EPPING (NORTH) – LED SIGNAL UPGRADE

Commencing at 0200 hours on **Saturday, 13th October 2018**, and continuing until 0200 hours on Monday, 15th October 2018, the following work will be carried out:

The existing signals EG21, EG23, EG25, EG27 and EG33 will be replaced with new LED type signal heads, the indications displayed and form of signal will remain the same.

VER29082018

Neil Hook

Commissioning Manager – Signals

Mob: 0423 636 577

Email: neil.hook@transport.nsw.gov.au**Kit Yue**

Signal Design Engineer - Signalling & Control Systems, Engineering & System Integrity

Tel: (02) 8574 2978 (external) 4 2978 (internal)

Email: kit.yue@transport.nsw.gov.au

NORTH SYDNEY – SPEED SIGN CHANGES

Since **Friday, 5 October 2018**, the following work was carried out at North Sydney;

- The 60 speed sign on the Down Shore at 5.300km was replaced by a 50 speed sign.

Cameron Ly

Group Leader, Track Design, Engineering & Systems Integrity
Sydney Trains

Tel: 9536 3454 (external) 6 3455 (internal)

Email: Cameron.Ly@transport.nsw.gov.au

DUNMORE – SPEED SIGN CHANGES

Since **Friday, 12 October 2018** the following work has been carried out at Dunmore;

- X35 speed sign for 52B Points in the Up Direction at 110.950km has been installed.

Cameron Ly

Group Leader, Track Design, Engineering & Systems Integrity
Sydney Trains

Tel: 9536 3454 (external) 6 3455 (internal)

Email: Cameron.Ly@transport.nsw.gov.au

STATUS OF TOM NOTICES

<i>Number</i>	<i>Title</i>	<i>Issued</i>	<i>Effective</i>
001 – 2007	Introduction of TOM Notices	13/09/07	13/09/07
018 – 2007	Emergency equipment boxes Rail	01/11/07	19/11/07
001 – 2012	OMET 266: Operation of Y-Set Trains	02/02/12	12/02/12
010 – 2012	48 Class: Train Operations Manual (TOM)	25/10/12	04/11/12
003 – 2013	48 Class: Wheels	07/02/13	10/02/13
015 – 2013	OMET 200: Minimum Standards for Electric Trains	30/05/13	09/06/13
002 – 2014	OMET 220: Wheelslip light indications	20/02/14	02/03/14
005 – 2014	Operation of T-Set (Tangara) Train fitted with ATP equipment	03/04/14	14/04/14
004 – 2016	OMET 262: Failure of Train Management System	14/07/16	24/07/16
001 – 2017	Incorporation of Waratah, Oscar and Millennium TOM Notices and SAFE Notices into the TOM	19/01/17	29/01/17
003 – 2017	Exception to TWP 100	19/01/17	29/01/17
007 – 2017	WAR 208: Main Power Faults	30/03/17	09/04/17
005 – 2017	TWP 150: Damaged or Missing Window Glass	06/04/17	16/04/17
009 – 2017	Operation of H-set (OSCAR) trains fitted with ATP	25/05/17	04/06/17
008 – 2017	TWP 176: Wayside Train Condition Monitoring	06/07/17	16/07/17
004 – 2017	TWP 174 Ice Radio	20/07/17	31/07/17
015 – 2017	Train crew relieved in service & relay driver	08/11/17	19/11/17
016 – 2017	WAR 030 Minimum Standards	23/11/17	03/12/17
018 - 2017	Amendment to OMET 200	14/12/17	24/12/17
003 - 2018	Trial of Millennium trains fitted with ATP	21/06/18	01/07/18
002 – 2018	Trial of Waratah trains fitted with ATP	26/04/18	06/05/18
011 - 2018	Trial of C-Set trains fitted with ATP	19/07/18	29/07/18
012 - 2018	Control Circuit Failure	23/08/18	02/09/18
005 - 2018	OMET 242 Reverser handle jams in forward or reverse	18/08/18	28/08/18
006 - 2018	OMET 250 Applying power from the rear	18/08/18	28/08/18
007 - 2018	TWP 100 Responsibilities of Train Crews	18/08/18	28/08/18
008 - 2018	TWP 154 Responding to an incapacitated Driver or Guard	18/08/18	28/08/18
013 - 2018	Trial of K sets fitted with ATP	17/08/18	27/08/18
016 - 2018	Network Rules Operational standards update	17/08/18	27/08/18

STATUS OF PERMANENT SAFE NOTICES

<i>Number</i>	<i>Title</i>	<i>Issued</i>	<i>Effective</i>
005 - 2018	Trial of worksite delineation markers	22/03/18	01/04/18
006 - 2018	Network Communications	17/05/18	27/05/18
007 - 2018	Unreliable track circuit operation	10/05/18	20/05/18
008 - 2018	Shared Corridor Protocols – MFN - SSFL	30/04/18	10/05/18
009 - 2018	Operation of passenger F1	24/05/18	07/06/18
010 - 2018	Planning & Management at abutting interface	02/07/18	12/07/18
011 - 2018	NPR 711 – Using lookouts	10/07/18	20/07/18
012 - 2018	Trial of Signal Key Switches ending	14/08/18	24/08/18
014 - 2018	Protecting Worksites less than 500M apart in LPA	14/08/18	24/08/18

Steve Swanson
Network Rules Specialist
Tel: 0428416505
Email: stephen.swanson@transport.nsw.gov.au

STATUS OF NETWORK MANUALS AND FORMS

Network Manuals

<i>Network Local Appendices</i>	RailSafe Website	Online documents
<i>Operator Specific Procedures</i>	RailSafe Website	Online documents
<i>Network Rules</i>	RailSafe Website	Online documents
<i>Network Procedures</i>	RailSafe Website	Online documents
<i>Forms</i>	RailSafe Website	Online documents (or order as applicable)

<i>Title</i>	<i>Status Sheet</i>	<i>Date issued</i>
<i>Train Working Procedures</i>		
TWP 100 (New)	4	November 2015
TWP 102	3	May 2012
TWP 106	3	May 2012
TWP 108	4	May 2012
TWP 110	3	May 2012
TWP 112	3	November 2015
TWP 114 (New)	4	May 2012
TWP 116	3	November 2015
TWP 118 (New)	4	May 2012
TWP 120	3	May 2012
TWP 122	3	May 2012
TWP 124	3	May 2012
TWP 126	3	May 2012
TWP 128	3	May 2012
TWP 130	3	May 2012
TWP 132	3	May 2012
TWP 134	3	May 2012
TWP 136 (New)	4	November 2015
TWP 138 (New)	4	November 2015
TWP 142	3	May 2012
TWP 144	5	May 2012
TWP 146	3	May 2012
TWP 148	3	May 2012
TWP 150 (New)	4	November 2015
TWP 152 (New)	4	November 2015
TWP 154	3	May 2012
TWP 156 (New)	6	November 2015
TWP 158	3	May 2012
TWP 160 (New)	4	November 2015
TWP 162	3	May 2012
TWP 164	4	May 2012
TWP 166	3	May 2012
TWP 168	3	May 2012
TWP 170	3	May 2012
TWP 172	4	May 2012
TWP 174 (New)	2	November 2015
TWP 176 (New)	1	November 2015
TWP 182 (New)	1	November 2015
TWP 184 (New)	1	November 2015
TWP 188 (New)	1	November 2015

REQUESTS FOR NETWORK MANUALS AND FORMS

Please regularly check that your Network Manuals and Forms are up-to-date and include the current Status Sheet numbers for each section, as listed in the most recent Weekly Notice.

If your manuals do not have the correct Status Sheets, they have not been properly amended and the Safeworking information will not be up-to-date.

All Sydney Trains staff issued with Network Manuals and who require regular updates and amendments need to contact their distribution officer, as listed in the most recent Weekly Notice, to have their name and contact details included in the distribution list. This will ensure that you receive all updated Network Manuals and Forms.

All requests to receive Safeworking documentation must be forwarded through your controlling officer to the appropriate distribution officer.

Those outside Sydney Trains can access Safeworking information by visiting the RailSafe website at www.railsafe.org.au

DISTRIBUTION OFFICERS**Sydney Trains****Safety and Environment****Maria Economou**

Safety Support

☎ 2 4502 🖨 2 1840

✉ Maria.Economou@transport.nsw.gov.au

Operations**Gary Poulson**

Team Leader TCAC

☎ 9379 1702

✉ gary.poulson@transport.nsw.gov.au

Paul Bartolo

Crew Manager – Blacktown/Richmond

☎ 42828

✉ Paul.Bartolo@transport.nsw.gov.au

Emma Bunting

Area Manager - Flemington

☎ 9536 8844

✉ emma.bunting@transport.nsw.gov.au

Paul Bartolo

Area Manager - Blacktown

☎ 25938

✉ Paul.Bartolo@transport.nsw.gov.au

David Allison

Area Manager - Mortdale

☎ 42624

✉ david.allison@transport.nsw.gov.au

Matthew Quinn

Area Manager – Cronulla/Waterfall

Tel: 69378

✉ matthew.quinn@transport.nsw.gov.au

Mark Karouche

Area Manager - Campbelltown/Leppington

☎ 91755

✉ MARWAN.KOUROUCHE@transport.nsw.gov.au

Rhys Blakey

Crew Manager Hornsby/North Sydney

☎ 9224 2044

✉ rhys.blakey@transport.nsw.gov.au

Anthony Robb

Crew Manager Penrith

☎ 42084

✉ Anthony.robb@transport.nsw.gov.au

Hana Farhat

Business Support Officer

☎ 39435

✉ Hana.Farhat2@transport.nsw.gov.au

William Morrison

Signal Box Operations — North

☎ 9 1057

✉ William.Morrison@transport.nsw.gov.au

Greg Oxley

Operations - Rail Management Centre (RMC)

☎ 9 4255 🖨 9 4438

✉ Greg.Oxley@transport.nsw.gov.au

Nick Hayek

Crew Manager - Auburn

☎ 35982

✉ nick.hayek@transport.nsw.gov.au

Fiona Eid

Administration Assistant Central

☎ 9379 4489

✉ fiona.eid@transport.nsw.gov.au

Rochelle Takai

Administration Support Campbelltown

☎ 0407976529

✉ rochelle.takai@transport.nsw.gov.au

Jason Cooper

Customer Service — Central

☎ 9 2776 9 3168

✉ Jason.Cooper@transport.nsw.gov.au

Megan McRae

Customer Service - North West

☎ 9848 9850

✉ megan.mcrae@transport.nsw.gov.au

Mario Chalouhi

Train Crew Standards Manager

☎ 42616

✉ Mario.Chalouhi@transport.nsw.gov.au

Mohamad Chahine

Signal Box Operations - Sydenham

☎ 37705

✉ Mohamad.Chahine@transport.nsw.gov.au

Ashraf Riyadh

Customer Service – Illawarra

☎ 27728

✉ Mohamad.Chahine@transport.nsw.gov.au

Megan Parker

Service Delivery Response

☎ 04191226502

✉ megan.parker@transport.nsw.gov.au

Maintenance**Fleet Maintenance****Hoshedar Movdawalla**

Fleet Maintenance Sydney Trains

☎ 2 0532 2 1274

✉ HOSHEDAR.MOVDAWALLA@transport.nsw.gov.au

Ram Ramaswamy

Fleet Maintenance Sydney Trains

☎ 2 0523 2 1274

✉ RAMYAVARAN.RAMASWAMY@transport.nsw.gov.au

Network Maintenance**Shannon Newton**

Track Access Coordinator – North

☎ 95363791

✉ Shannon.Newton@transport.nsw.gov.au

Xerxes Francia

Track Access Coordinator – North

Hornsby Network Base

☎ 3 6740

✉ Xerxes.Francia@transport.nsw.gov.au

Jonathan Barnes

Track Access Coordinator – West

Blacktown Network Base

☎ 87512

✉ Jonathan.Barnes@transport.nsw.gov.au

Ennio Soster

SCE

Project Delivery Electrical

☎ 25236 25917

✉ ENNIO.SOSTER@transport.nsw.gov.au

Daljit Kaur

Infrastructure Maintenance — Facilities

☎ 2 5922 2 5950

✉ Daljit.Kaur@transport.nsw.gov.au

Adrian Aquilina

Team leader - Strathfield Mains

☎ 97526610

✉ adrian.aquilina@transport.nsw.gov.au

Christina Morgan

Administration Support

ICON

☎ 9379 6051

✉ Christina.Morgan@transport.nsw.gov.au

Lorinda Melvin

Administration Support

☎ 0439510480

✉ lorinda.melvin@transport.nsw.gov.au

Edward Lusik

Team Leader Signals

CBD

☎ 95368135

✉ edward.lusik@transport.nsw.gov.au

Major Works**Greg Page**

Infrastructure Track

☎ 25375

✉ gregory.page@transport.nsw.gov.au

Michael Warner

Signals and Electricity

☎ 9848 9333

✉ michael.warner@transport.nsw.gov.au

Logistics & Supply Chain**Murari Singh**

Contract Assurance Administrator

☎ 02 9848 9698

✉ Murari.Singh@transport.nsw.gov.au

Asset Management**Anurag Nehra**

Operations Safeworking Supervisor

☎ 0429 362419

✉ anrag.nehra@transport.nsw.gov.au

Engineering & System Integrity**Teresa Sitjar**

Signalling & Control Systems

☎ 42458

✉ Teresa.Sitjar@transport.nsw.gov.au

Yass Zahab

Geotechnical Services

☎ 2 7589 2 7786

✉ Yassine.El-Zahab@transport.nsw.gov.au

Richard Agostino

C and CS

☎ 2 0875 9 2137

✉ Richard.Agostino@transport.nsw.gov.au

Peter Nilon

Survey Group

☎ 9848 9904

✉ peter.nilon@transport.nsw.gov.au

Human Resources**Robert Neloski**

Training — Learning and Development

☎ 2 7567

✉ robert.neloski@transport.nsw.gov.au

Finance and Corporate Services**Graham Church**

Compliance and Review Unit

☎ 4 2143 5 0321

✉ Graham.Church@transport.nsw.gov.au

NSW TrainLink**Adam Tonkin**

Operational Improvement Manager

☎ 8574 2960 0417694249

✉ ADAM.TONKIN@transport.nsw.gov.au

Ashley Brandse

Associate Director Operations North & Central

☎ 4962 9820

✉ ASHLEY.BRANDSE@transport.nsw.gov.au

Emma Abernathy

Area Manager Newcastle

Tel: 4907 7540 0437308515

✉

EMMA.ABERNATHY@transport.nsw.gov.au

Netti Byrnes



Area Manager Central Coast

☎ 43499210 0458261501



✉ Annette.Byrnes@transport.nsw.gov.au

Robert Blanch

Area Manager Hunter & Regional North

 43499210 0458261501 ROBERT.BLANCH@transport.nsw.gov.au**Leisa Case**



Area Manager Central Intercity

  0429900371 Annette.Byrnes@transport.nsw.gov.au**Dwayne Purcell**

Area Manager Central Regional

 0428670580 DWAYNE.PURCELL@transport.nsw.gov.au**Michael Dorrian**

Area Manager South Coast

  0439743316 Michael.dorrian@transport.nsw.gov.au**Tiffany Glasgow**



Area Manager West

 0439743316 Tiffany.glasgow@transport.nsw.gov.au**Ian Mondon**

Area Manager South Main

 0427016255**Tod James**

Shift Manager Taree

 65924786 tod.james@transport.nsw.gov.au

NOTES

NOTES

NOTICE TO SUBSCRIBERS

The Weekly Notice is issued every Tuesday, and takes effect on the following Monday.

Those who require the Weekly Notice must ensure that they receive it and are aware of the changes that affect their work duties and responsibilities.

Director Safety and Standards

Sydney Trains

Level 4, 36-46 George Street

Burwood NSW 2134

Tuesday, 25 September 2018